



SWISS+TOOLS[®]

S w i s s
P S C
1905

by **SWISS+TOOLS**



PWLN
Seite/page 12



SVPB
Seite/page 15

NEW



Modulare Bohrstangen/Modular boring bars
Seite/page 19

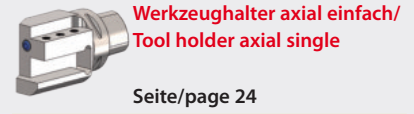

Seite/page 24



SCLC
Seite/page 12



DVPN
Seite/page 15



SCLC
Seite/page 20

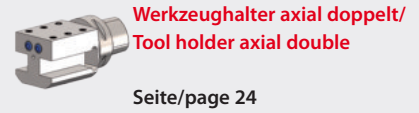

Seite/page 24



PCLN
Seite/page 12



SSBC
Seite/page 16

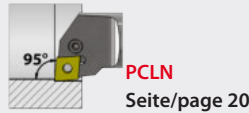

PCLN
Seite/page 20

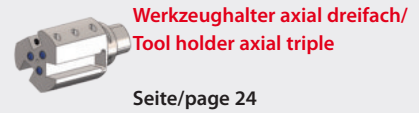

Seite/page 24



SDUC
Seite/page 13



PSBN
Seite/page 16



SDQC
Seite/page 20

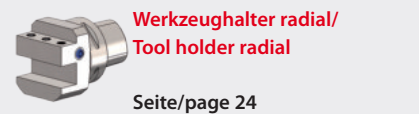

Seite/page 24



PDUN
Seite/page 13



SSSC
Seite/page 16

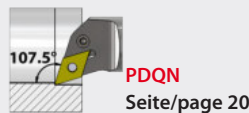

PDQN
Seite/page 20

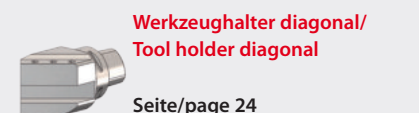

Seite/page 24



SDJC
Seite/page 13



PSSN
Seite/page 16



Bohrstangenhalter/Boring bar holder
Seite/page 21



Seite/page 22



PDJN
Seite/page 13



SCMC
Seite/page 16



Aussengewinde External thread
Seite/page 23



Seite/page 22



SDHC
Seite/page 13



PCMN
Seite/page 16



Innengewinde Internal thread
Seite/page 23

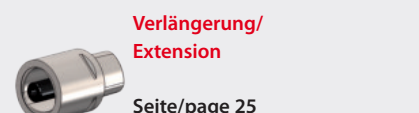

Seite/page 25



PDHN
Seite/page 13



SDNC
Seite/page 16



Multitask Werkzeuge/Multitask tools
Seite/page 17

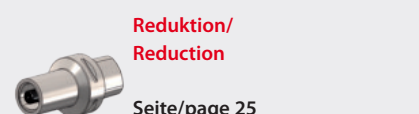

Seite/page 25



SVUB
Seite/page 14



PDNN
Seite/page 16

NEW



Quick change Werkzeughalter Tool holders
Seite/page 9

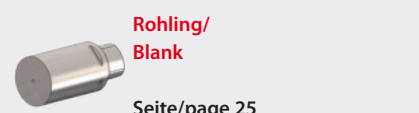

Seite/page 25



DVUN
Seite/page 14



SVVB
Seite/page 17

NEW



Kühlmittel Set/Coolant set
Seite/page 25



Seite/page 26



SVJB
Seite/page 14



DVVN
Seite/page 17

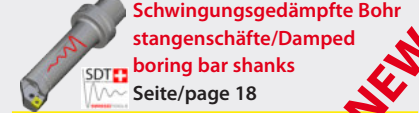

Seite/page 18

NEW

Bohrstangen mit Wechselschneidköpfen

- alle Wechselschneidköpfe sind mit Hochleistungskühlung ausgestattet.
- Werkzeugverschleiss tritt hauptsächlich am auswechselbaren Schneidkopf auf, der Adapter hält somit länger.
- In Kombination mit den SDT Bohrstangen ist das Konzept perfekt für Operationen mit langen Überhängen und bei Vibrationsneigung.

Boring bars with exchangeable cutting heads

- all exchangeable cutting heads are equipped with high performance coolant.
- Tool wear appears mainly at the changeable head, the life time of the tool adapter is therefore longer.
- In combination with SDT the tool concept is perfect for long cantilever extensions and while fighting with vibrations.

NEW
HP
inside

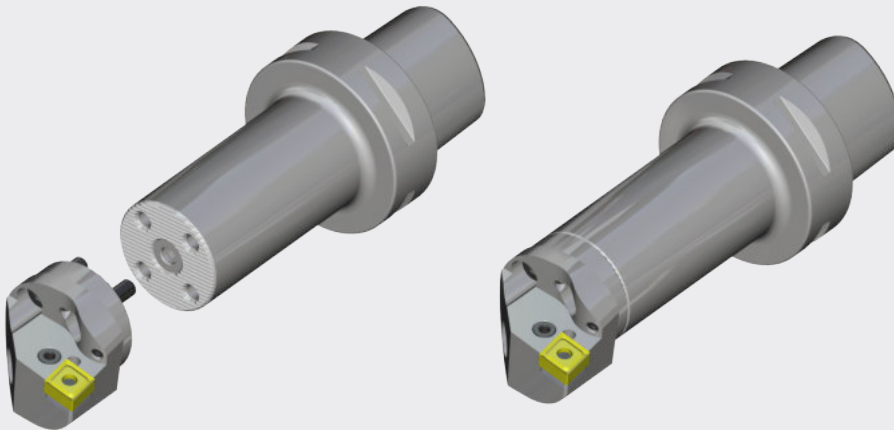

SWISS DAMPENING TECHNOLOGY

Schwingungsgedämpfte Bohrstangenschäfte

- Produktivitätsgewinn dank der unterdrückten Schwingungen können die Schnittdaten beträchtlich erhöht werden
- Verbesserte Oberflächengüte
- Verbesserte Prozesssicherheit
- Verbesserte Spanabfuhr
- Reduzierte Kosten pro Bauteil

Damped boring bar shanks

- Productivity improvement: thanks to reduced vibrations, the cutting conditions can be improved remarkable
- Better surface quality
- Improved process stability
- Better chip evacuation
- Reduced cost per part

NEW
SDT
SWISS TOOLS

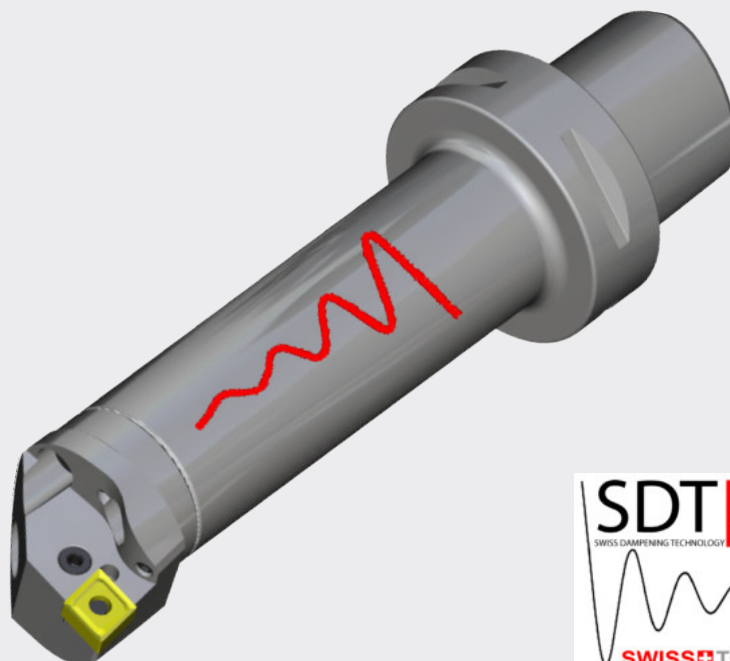

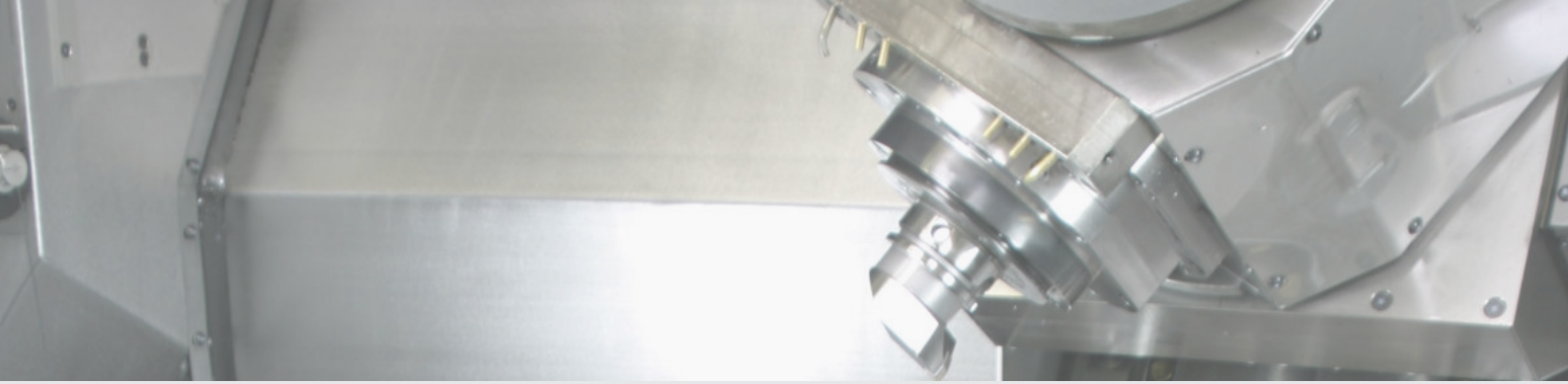

QUICK-CHANGE Werkzeugsysteme für Multi-Task und Drehmaschinen

QUICK-CHANGE tool system for multi-tasking and turning lathes

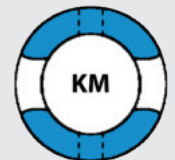

Systemlösungen / System solution

- Produktivitätssteigerung durch Reduktion der Nebenzeiten.
- Werkzeugwechsel in kürzester Zeit
- Beste Wiederholgenauigkeit mit definierten, gleichbleibenden Werkzeugkonturen
- Für alle Maschinentypen geeignet.
- Flexibel für HSK, PSC und KM Werkzeuge
- Kosteneffizient System
- Increase productivity by reducing non-productive time
- Very quick tool changing time
- Perfect repeatability with fixed tool geometry
- Useable for all machine brands
- Flexible with HSK, PSC and KM tools
- Cost efficient

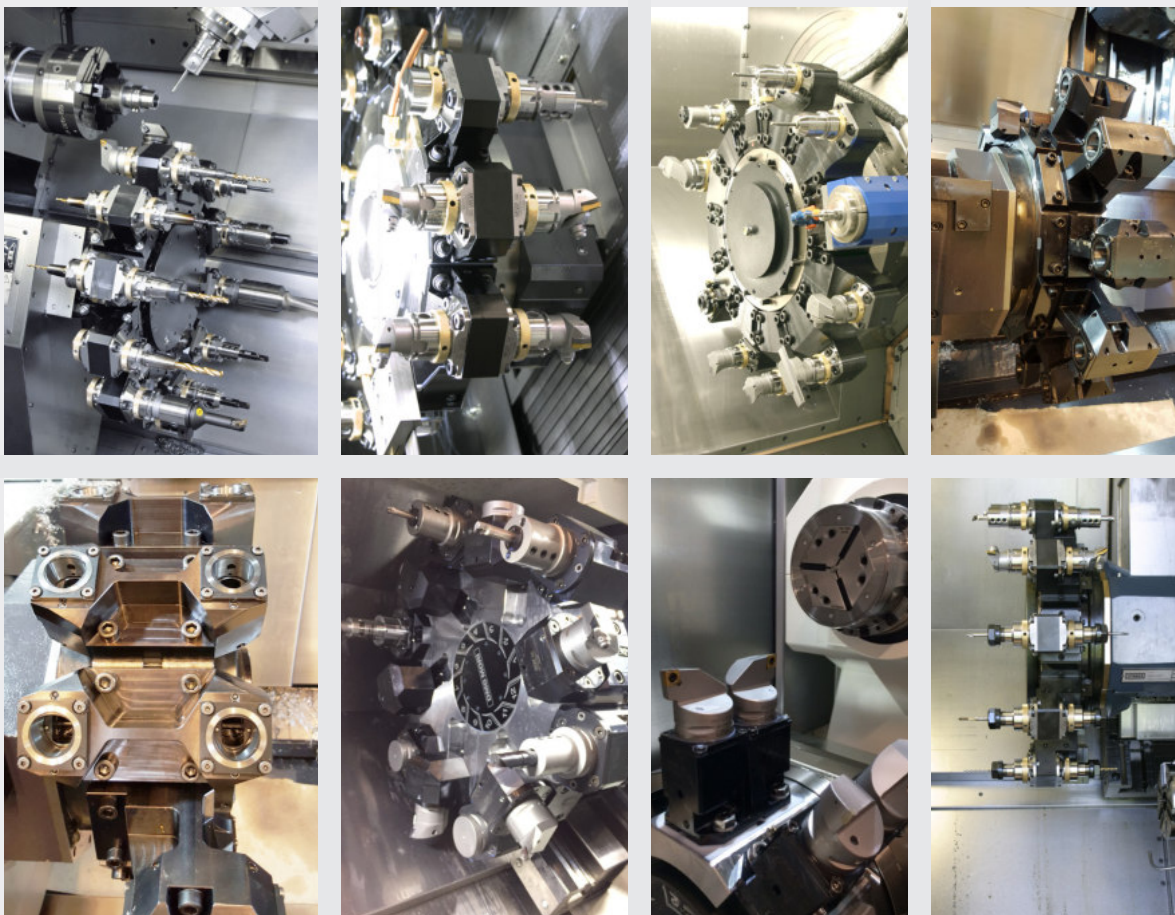

Online Konfigurator

- Angetriebene- und statische Werkzeuge für Drehmaschinen
- www.swisstools.org

Online configurator

- for static and rotating tools
- www.swisstools.org



Adaptionsmöglichkeiten Drehrevolverscheiben / Adaptation to turrets

Werkzeughalter mit Schnellwechselsystem

Das Werkzeughalterprogramm umfasst innovative und technisch ausgereifte Lösungen für alle gängigen CNC-Drehzentren. Wir bieten Ihnen Lösungen, die optimal auf das Maschinenfabrikat abgestimmt sind, ob mit BMT/ VDI oder anderen Anbindungen.

Die Schnittstelle des Schnellwechselsystems ist DIN/ISO normiert, und für die Größen HSK 40/63/100, PSC40/50/63 und KM 40/50/63 vorhanden.

Der Werkzeugwechsel ist einfach und schnell durchführbar. Die Nebenzeiten werden minimiert und damit die Produktivität gesteigert.

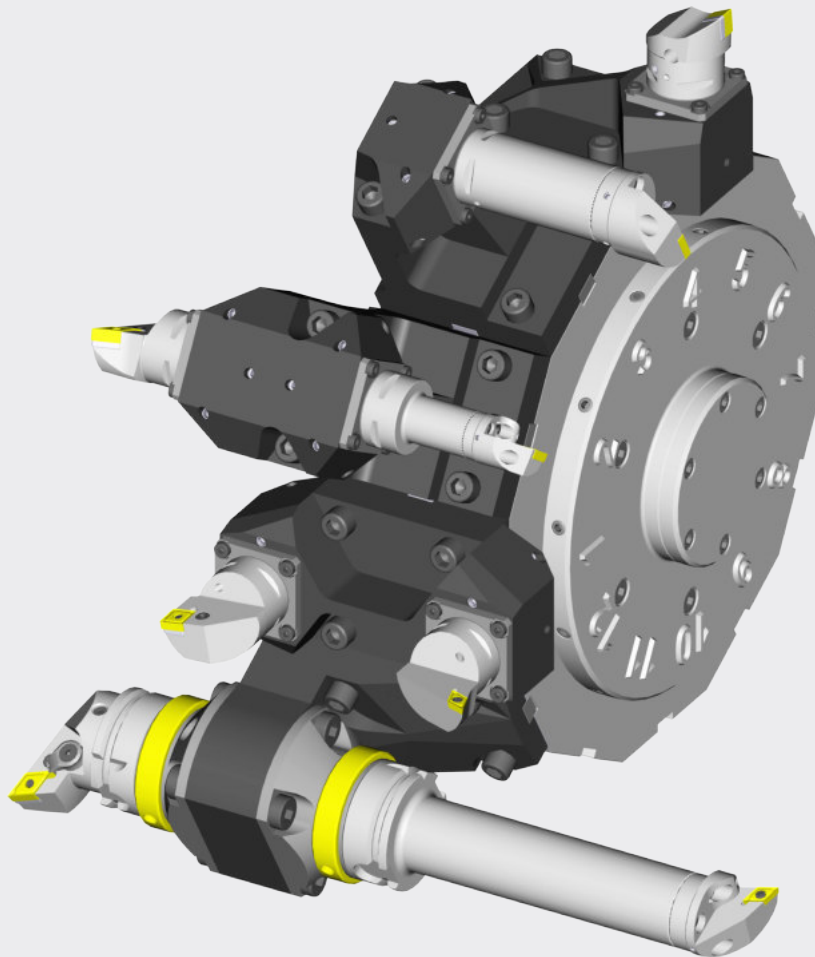

Tool holder with QUICK-CHANGE system

The whole range of the system contains solutions for the most CNC lathes centres. Complementary on the machine tool with BMT / VDI or other connections.

The tool connection is based on DIN/ISO standards with HSK 40/63/100, PSC40/50/63 and KM 40/50/63.

The tool change is very simple and quick. Non-productive times are minimized and the productivity will increase.

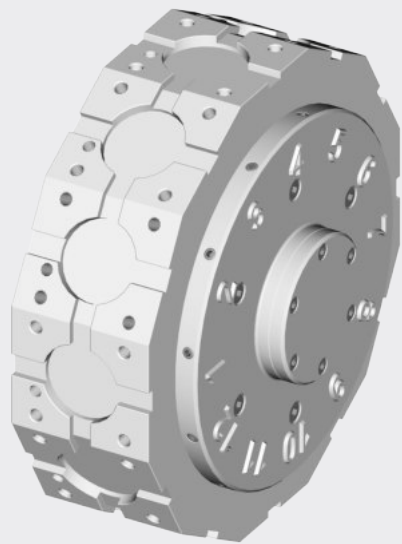

Revolverscheibe / Turret
BMT/VDI/...

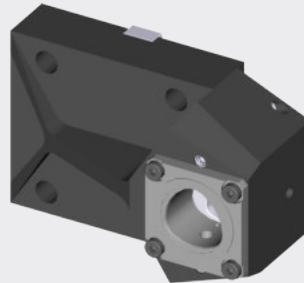

Werkzeughalter
einfach gerade

Tool holder
single straight

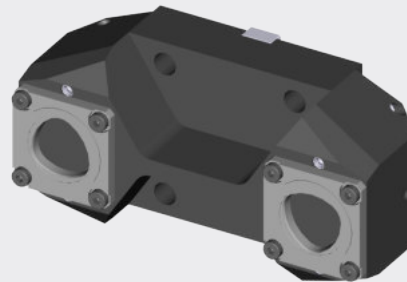

Werkzeughalter
doppelt gerade

Tool holder
double straight

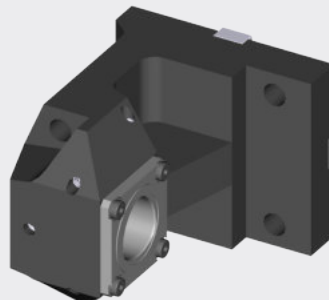

Werkzeughalter
einfach abgewinkelt

Tool holder
single angular

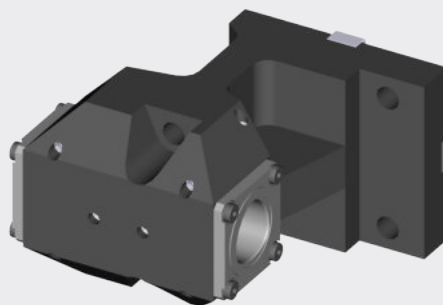

Werkzeughalter
doppelt abgewinkelt

Tool holder
double angular

HSK / PSC / KM Spanneinheiten /

HSK / PSC / KM clamping unit

Die Werkzeughalter werden entweder mit einer HSK oder einer PSC Spanneinheit ausgerüstet.

Die Werkzeughalter sind somit flexibel auf die Kundenbedürfnisse anpassbar.

Spanneinheiten sind in den Grössen HSK 40/63/100, PSC40/50/63 und KM 40/50/63 erhältlich

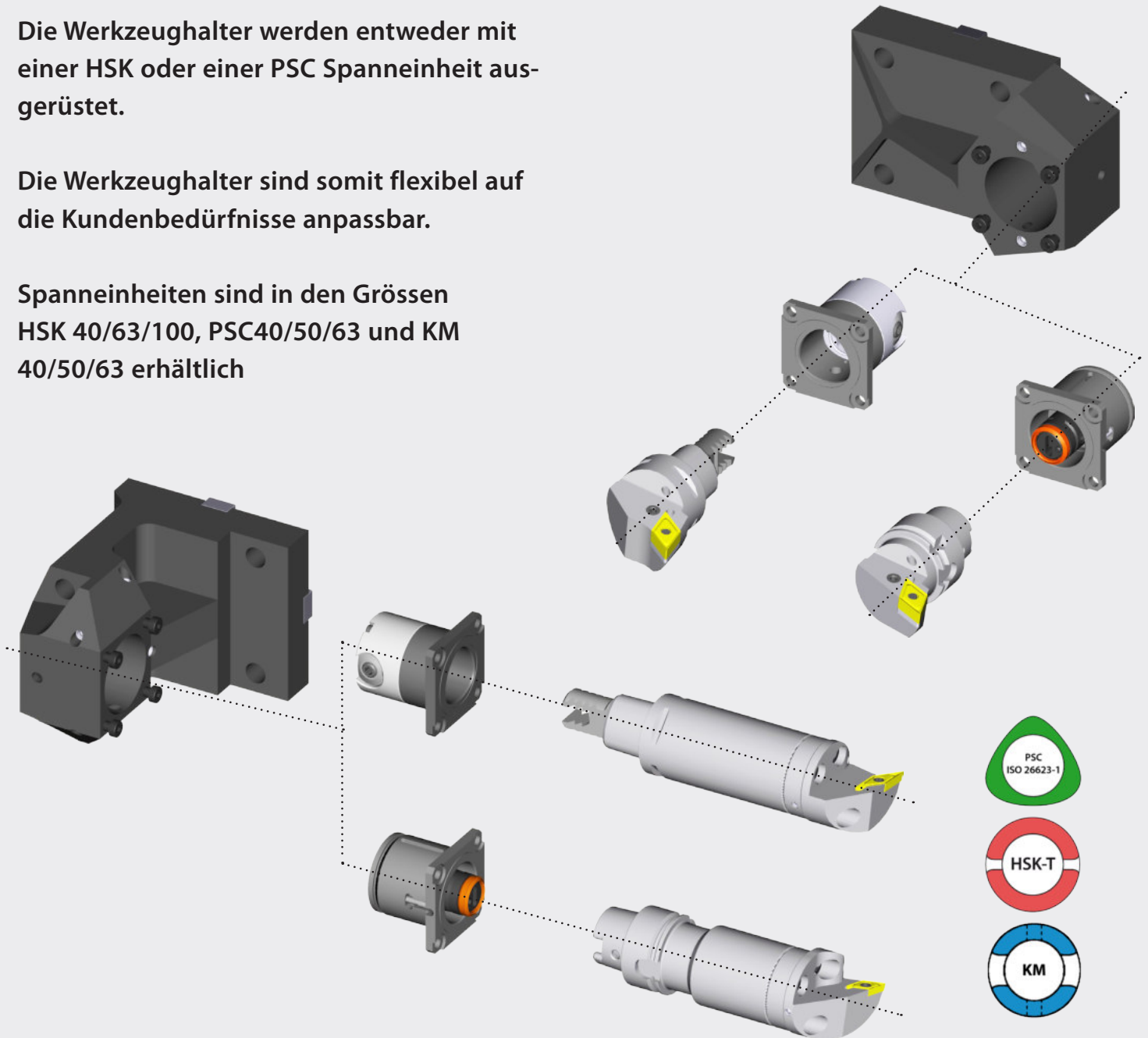

Tool holders are equipped with HSK or PSC clamping units.

Very flexible for customer needs.

Clamping units are available in HSK 40/63/100, PSC40/50/63 and KM 40/50/63.

**Quick-Change Werkzeughalter
und Spanneinheiten**

**Quick-Change Toolholders
and clamping units**

**Werkzeughalter mit VDI Schaft
abgewinkelt / DIN 69880**

**Toolholder with VDI shank
angular / DIN 69880**

- Schaft mit Doppelverzahnung R/L Einsatz möglich
- für Innenkühlung

- shank with double seration profile R/L usage possible
- for inner coolant supply

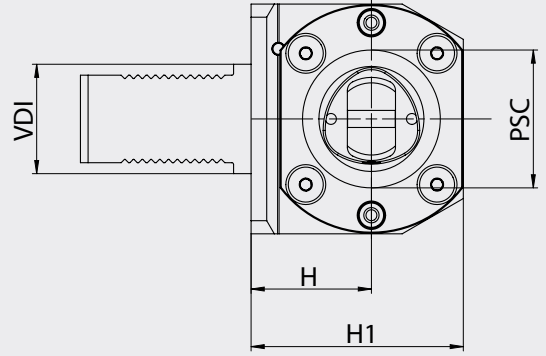
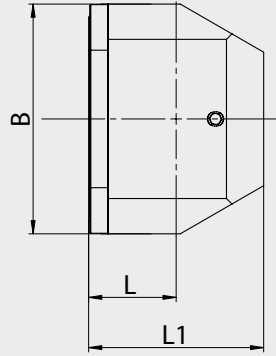
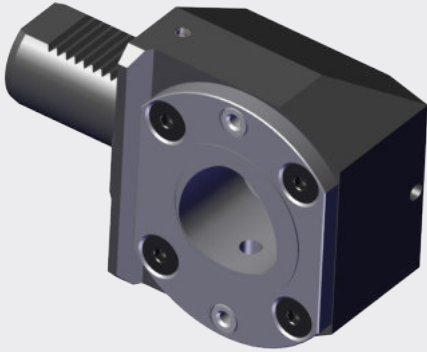

Bestell-Nr. / Order number	PSC	H	H1	VDI	L	L1	B
REA.PS4.VD3.041	40	41	65	30	21	56	60
REA.PS4.VD4.051	40	51	75	40	30	86	75
REA.PS5.VD4.053	50	53	85	40	40	80	86
REA.PS5.VD5.053	50	53	85	50	40	80	86
REA.PS6.VD4.053	63	53	95	40	40	80	105
REA.PS6.VD5.055	63	55	97	50	40	80	105

**Werkzeughalter mit VDI Schaft
gerade / DIN 69880**

**Toolholder with VDI shank
straight / DIN 69880**

- Schaft mit Doppelverzahnung R/L Einsatz möglich
- für Innenkühlung

- shank with double seration profile R/L usage possible
- for inner coolant supply

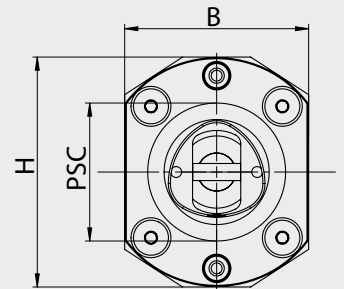
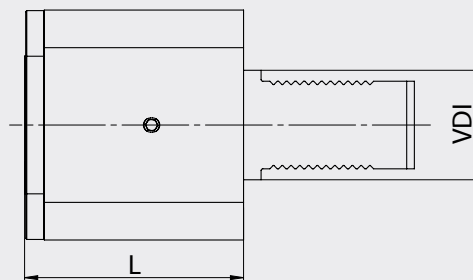
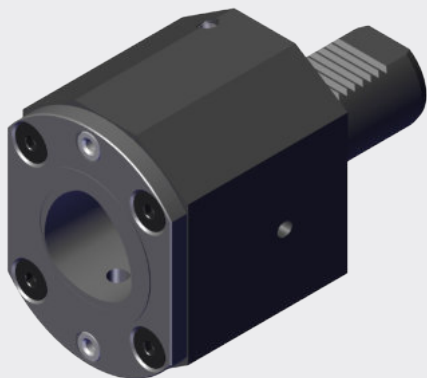

Bestell-Nr. / Order number	PSC	L	H	VDI	B
RER.PS4.VD3.070	40	70	60	30	52
RER.PS4.VD4.075	40	75	75	40	75
RER.PS5.VD4.085	50	85	82	40	75
RER.PS5.VD5.085	50	85	91	50	83
RER.PS6.VD4.090	63	90	105	40	84
RER.PS6.VD5.100	63	100	105	50	84

Quadratischer Schaft

- Anschluss für Innenkühlung

Rectangular shank

- Coupling for inner coolant supply

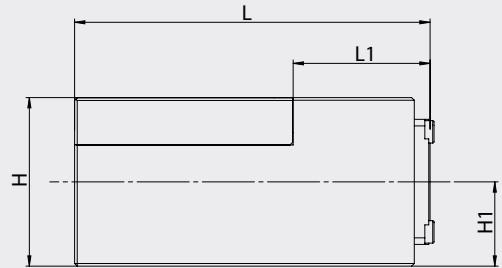
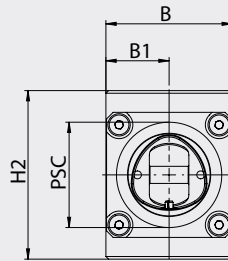
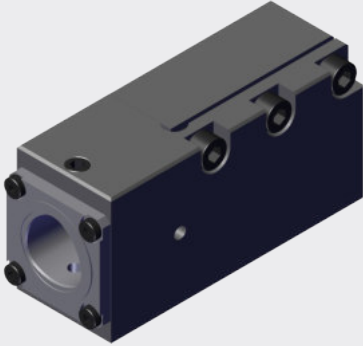

Bestell-Nr. / Order number	PSC	B	B1	H	H1	H2	L	L1
RER.PS4.V20.140	40	48	24	40	20	58	140	50
RER.PS4.V25.140	40	48	24	50	25	58	140	57
RER.PS4.V32.135	40	48	24	64	32	64	135	52

PSC DIGITALE FEINBOHRWERKZEUGE DIGITAL FINE BORING HEADS

- ein Display für alle Feinbohrköpfe
Ø 0.3 mm - 2205.0 mm
- Anzeige umkehrbar (Links-/ Rechtshänder)
- mm/inch umschaltbar
- Standard AAA Batterie zur Stromversorgung
- Display wird über Magnetkraft am Werkzeug gehalten
- Einstellgenauigkeit 0.001mm im Durchmesser
- direktes Wegmeßsystem (kein Umkehrspiel)
- keine Batterie und Auswerteelektronik im Werkzeug verbaut
- sehr einfache Bedienung
- digital und analog einsetzbar
- one display for all fine boring heads diameter 0.3 mm – 2205 mm
- display reversible (LH/RH)
- mm/inch switchable
- standard AAA battery required
- display unit will docked with magnetic forces at the tool
- 0.001 accuracy in diameter
- direct measurement system (no backlash)
- no battery and electronic evaluation unit inside the tool
- very easy operation
- for digital and analog use





Hochleistungskühlung

- für effiziente Drehbearbeitung
- optimale Kühlung durch fest ausgerichtete **High Pressure** Kühldüsen
- verbesserte Spankontrolle
- höhere Bearbeitungssicherheit
- mehr Zerspanvolumen
- kürzere Bearbeitungszeiten

High performance coolant

- to turn efficiently
- optimal cooling by fix orientated **High Pressure** coolant nozzles
- improved chip control
- higher manufacturing security
- higher chip removal rate
- shorter machining time

Klemmhalter

- alle Klemmhalter die mit dem **HP ready** Symbol markiert sind, können auf Hochleistungskühlung aufgerüstet werden.

Turning tool

- all turning tools which are marked with the **HP ready** symbol, can be set up with the high performance coolant.

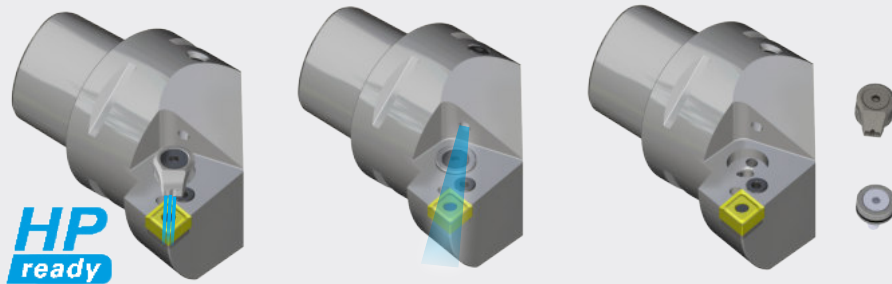

Bestell-Nr. /
Order number

CHP.PCX.000.022

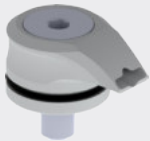

- Hochleistungskühlmittel Set beinhaltet:
 - HP Düse
 - O-Ring

- High performance coolant set included:
 - HP coolant nozzle
 - O-ring

Kühlung und Klemmsysteme

Cooling and clamping systems

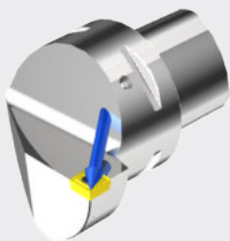

- Spansystem: Die Wendeplatte wird mittels Schraubenklemmung Typ S gespannt.
- Kühlsystem: Klemmhalter für positive Wendeplatten besitzen eine ausgerichtete Kühlmitteldüse.

- Clamping system: The insert is tightened via screw clamping Type S.
- Cooling system: Turning tools for positive inserts feature an adjusted coolant nozzle.

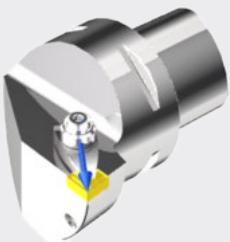

- Spansystem: Die Wendeplatte wird mittels Doppelklemmung Typ D gespannt.
- Kühlsystem: Klemmhalter mit Doppelklemmung verfügen über eine ausrichtbare Hochdruckkühldüse.

- Clamping system: The insert is tightened via double-clamping Type D.
- Cooling system: Turning tools with double-clamping feature an adjustable high-pressure coolant nozzle.

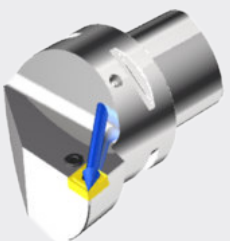

- Spansystem: Die Wendeplatte wird mittels Kniehebelspannung Typ P gespannt.
- Kühlsystem: Klemmhalter mit Kniehebelspannung besitzen eine ausgerichtete Kühlmitteldüse.

- Clamping system: The insert is tightened via knuckle joint Type P.
- Cooling system: Turning tools with knuckle joint-clamping feature an adjusted coolant nozzle.

Klemmhalter

Turning tool

- für effiziente Drehbearbeitung
- optimale Kühlung durch ausgerichtete Kühldüse und Hochdruckkühldüse
- Klemmhalter für Aussenbearbeitung können auch für die Innenbearbeitung verwendet werden unter Berücksichtigung des D1 min.

- to turn efficiently
- optimal cooling by adjusted cooling nozzle and high pressure cooling nozzle
- Turning tools for exterior machining may also be used for interior machining, in consideration of D1 min.



PWLN R/L 95°/80°



Bestell-Nr. / Order number	PSC	f	D1 min.	A	Wendeplatte/ Insert	Ersatzteile/ Spareparts
PS4.PWE.(R/L)LA.050-HP	40	27	50	50	WN .. 08 04 ..	P04
PS5.PWE.(R/L)LA.060-HP	50	35	65	60	WN .. 08 04 ..	P04
PS6.PWE.(R/L)LA.065-HP	63	45	80	65	WN .. 08 04 ..	P04

- Rechte Ausführung dargestellt
- Right hand shown

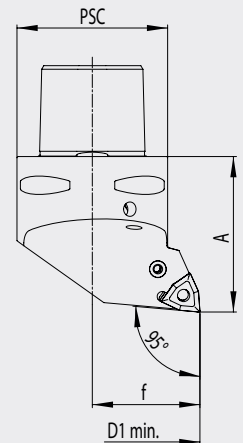

SCLC R/L 95°/80°



Bestell-Nr. / Order number	PSC	f	D1 min.	A	Wendeplatte/ Insert	Ersatzteile/ Spareparts
PS4.KCC.(R/L)LA.050	40	27	50	50	CC .. 12 04 ..	S01
PS5.KCC.(R/L)LA.060	50	35	65	60	CC .. 12 04 ..	S01
PS6.KCB.(R/L)LA.065	63	45	80	65	CC .. 09 T3 ..	S05
PS6.KCC.(R/L)LA.065	63	45	80	65	CC .. 12 04 ..	S01

- Rechte Ausführung dargestellt
- Right hand shown

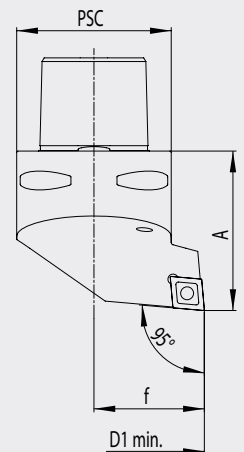

PCLN R/L 95°/80°



Bestell-Nr. / Order number	PSC	f	D1 min.	A	Wendeplatte/ Insert	Ersatzteile/ Spareparts
PS4.PCD.(R/L)LA.050-HP	40	27	50	50	CN .. 12 04 ..	P01
PS5.PCD.(R/L)LA.060-HP	50	35	65	60	CN .. 12 04 ..	P01
PS5.PCE.(R/L)LA.060	50	35	65	60	CN .. 16 06 ..	P02
PS6.PCD.(R/L)LA.065-HP	63	45	80	65	CN .. 12 04 ..	P01
PS6.PCE.(R/L)LA.065-HP	63	45	80	65	CN .. 16 06 ..	P02

Bestell-Nr. / Order number
CHP.PCX.000.022

- Hochleistungskühlmittel Set beinhaltet:
 - HP Düse
 - O-Ring
- High performance coolant set included:
 - HP coolant nozzle
 - O-ring

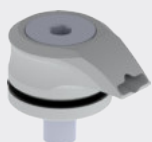

SDUC R/L 93°/55°



- Rechte Ausführung dargestellt
- Right hand shown

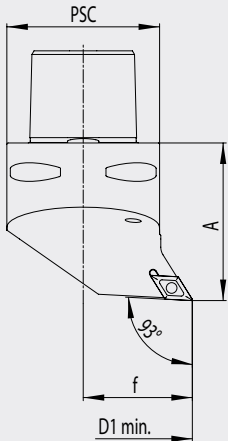

Bestell-Nr./ Order number	PSC	f	D1 min.	A	Wendeplatte/ Insert	Ersatzteile/ Spareparts
PS4.KDB.(R/L)UA.050	40	27	50	50	DC..11 T3..	S05
PS5.KDB.(R/L)UA.060	50	35	65	60	DC..11 T3..	S05
PS6.KDA.(R/L)UA.065	63	45	80	65	DC..07 02..	S10
PS6.KDB.(R/L)UA.065	63	45	80	65	DC..11 T3..	S05



PDUN R/L 93°/55°



Bestell-Nr./ Order number	PSC	f	D1 min.	A	Wendeplatte/ Insert	Ersatzteile/ Spareparts
PS4.PDF.(R/L)UA.050-HP	40	27	50	50	DN..15 06..*	P05
PS5.PDF.(R/L)UA.060-HP	50	35	65	60	DN..15 06..*	P05
PS6.PDF.(R/L)UA.065-HP	63	45	80	65	DN..15 06..*	P05

* DN..15 04.. möglich mit Unterlegplatte WDF.ER2.101.004

* DN..15 04.. possible with tip pad WDF.ER2.101.004



SDJC R/L 55°/93°



- Rechte Ausführung dargestellt
- Right hand shown

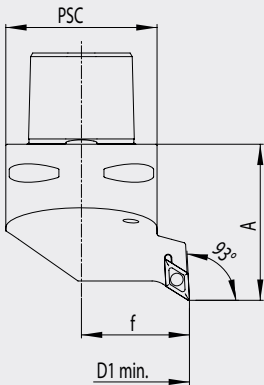

Bestell-Nr./ Order number	PSC	f	D1 min.	A	Wendeplatte/ Insert	Ersatzteile/ Spareparts
PS4.KDB.(R/L)JA.050-HP	40	27	50	50	DC..11 T3..	S05
PS5.KDB.(R/L)JA.060-HP	50	35	60	60	DC..11 T3..	S05
PS6.KDB.(R/L)JA.065-HP	63	45	80	65	DC..11 T3..	S05



PDJN R/L 55°/93°



Bestell-Nr./ Order number	PSC	f	D1 min.	A	Wendeplatte/ Insert	Ersatzteile/ Spareparts
PS4.PDF.(R/L)JA.050-HP	40	27	-	50	DN..15 06..*	P05
PS5.PDF.(R/L)JA.060-HP	50	35	-	60	DN..15 06..*	P05
PS6.PDF.(R/L)JA.065-HP	63	45	-	65	DN..15 06..*	P05



SDHC R/L 107.5°/55°



- Rechte Ausführung dargestellt
- Right hand shown

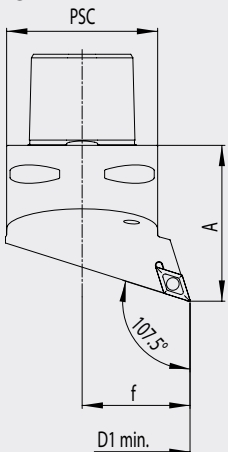

Bestell-Nr./ Order number	PSC	f	D1 min.	A	Wendeplatte/ Insert	Ersatzteile/ Spareparts
PS4.KDB.(R/L)HA.050-HP	40	27	50	50	DC..11 T3..	S05
PS5.KDB.(R/L)HA.060-HP	50	35	60	60	DC..11 T3..	S05
PS6.KDB.(R/L)HA.065-HP	63	45	80	65	DC..11 T3..	S05



PDHN R/L 107.5°/55°



Bestell-Nr./ Order number	PSC	f	D1 min.	A	Wendeplatte/ Insert	Ersatzteile/ Spareparts
PS4.PDF.(R/L)HA.050	40	27	50	50	DN..15 06..*	P05
PS5.PDF.(R/L)HA.060	50	35	60	60	DN..15 06..*	P05
PS6.PDF.(R/L)HA.065-HP	63	45	80	65	DN..15 06..*	P05

* DN..15 04.. möglich mit Unterlegplatte WDF.ER2.101.004

* DN..15 04.. possible with tip pad WDF.ER2.101.004



SVUB R/L 93°/35°



Bestell-Nr. / Order number	PSC	f	D1 min.	A	Wendeplatte/ Insert	Ersatzteile/ Spareparts
PS4.KVF.(R/L) UA.050	40	27	50	50	VB .. 16 04 ..	S07
PS5.KVF.(R/L) UA.060	50	35	65	60	VB .. 16 04 ..	S07
PS6.KVF.(R/L) UA.065	63	45	80	65	VB .. 16 04 ..	S07



SVUC R/L 93°/35°



Bestell-Nr. / Order number	PSC	f	D1 min.	A	Wendeplatte/ Insert	Ersatzteile/ Spareparts
PS4.KVB.(R/L) UA.050	40	27	50	50	VC .. 16 04 ..	S07
PS5.KVB.(R/L) UA.060	50	35	65	60	VC .. 16 04 ..	S07
PS6.KVB.(R/L) UA.065	63	45	80	65	VC .. 16 04 ..	S07



DVUN R/L 93°/35°

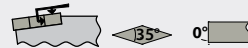

Bestell-Nr. / Order number	PSC	f	D1 min.	A	Wendeplatte/ Insert	Ersatzteile/ Spareparts
PS4.KVD.(R/L) UA.050	40	27	50	50	VN .. 16 04 ..	D07
PS5.KVD.(R/L) UA.060	50	35	65	60	VN .. 16 04 ..	D07
PS6.KVD.(R/L) UA.065	63	45	80	65	VN .. 16 04 ..	D07

- Rechte Ausführung dargestellt
- Right hand shown

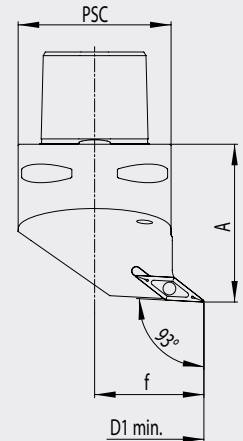

SVJB R/L 35°/93°



Bestell-Nr. / Order number	PSC	f	D1 min.	A	Wendeplatte/ Insert	Ersatzteile/ Spareparts
PS4.KVF.(R/L) JA.050	40	27	50	50	VB .. 16 04 ..	S07
PS5.KVF.(R/L) JA.060	50	35	65	60	VB .. 16 04 ..	S07
PS6.KVF.(R/L) JA.065	63	45	80	65	VB .. 16 04 ..	S07



SVJC R/L 35°/93°



Bestell-Nr. / Order number	PSC	f	D1 min.	A	Wendeplatte/ Insert	Ersatzteile/ Spareparts
PS4.KVA.(R/L) JA.050		27	50	50	VC .. 11 03 ..	S10
PS5.KVB.(R/L) JA.060	50	35	65	60	VC .. 16 04 ..	S07
PS6.KVB.(R/L) JA.065	63	45	80	65	VC .. 16 04 ..	S07

- Rechte Ausführung dargestellt
- Right hand shown

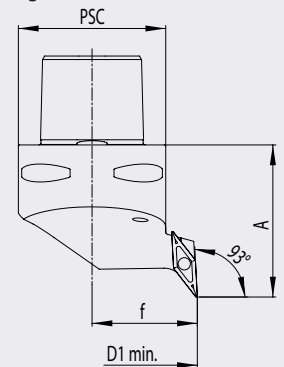

DVJN R/L 35°/93°

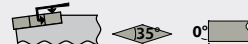

Bestell-Nr. / Order number	PSC	f	D1 min.	A	Wendeplatte/ Insert	Ersatzteile/ Spareparts
PS4.KVD.(R/L) JA.050	40	27	50	50	VN .. 16 04 ..	D07
PS5.KVD.(R/L) JA.060	50	35	65	60	VN .. 16 04 ..	D07
PS6.KVD.(R/L) JA.065	63	45	80	65	VN .. 16 04 ..	D07



SVPB R/L 117.5°/35°



- Rechte Ausführung dargestellt
- Right hand shown

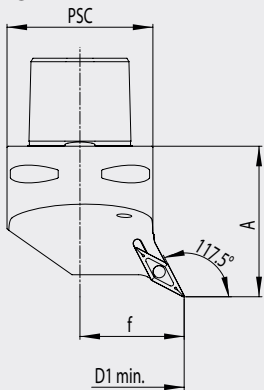

Bestell-Nr. / Order number	PSC	f	D1 min.	A	Wendeplatte/ Insert	Ersatzteile/ Spareparts
PS4.KVF.(R/L)PA.050	40	27	50	50	VB .. 16 04 ..	S07
PS5.KVF.(R/L)PA.060	50	35	65	60	VB .. 16 04 ..	S07
PS6.KVF.(R/L)PA.065	63	45	80	65	VB .. 16 04 ..	S07

SVPC R/L 117.5°/35°



Bestell-Nr. / Order number	PSC	f	D1 min.	A	Wendeplatte/ Insert	Ersatzteile/ Spareparts
PS4.KVB.(R/L)PA.050	40	27	50	50	VC .. 16 04 ..	S07
PS5.KVB.(R/L)PA.060-HP	50	35	65	60	VC .. 16 04 ..	S07
PS6.KVB.(R/L)PA.065-HP	63	45	80	65	VC .. 16 04 ..	S07

DVPP R/L 117.5°/35°



Bestell-Nr. / Order number	PSC	f	D1 min.	A	Wendeplatte/ Insert	Ersatzteile/ Spareparts
PS4.KVD.(R/L)PA.050	40	27	50	50	VN .. 16 04 ..	D07
PS5.KVD.(R/L)PA.060	50	35	65	60	VN .. 16 04 ..	D07
PS6.KVD.(R/L)PA.065	63	45	80	65	VN .. 16 04 ..	D07

SSBC R/L 90°/75°



- Rechte Ausführung dargestellt
- Right hand shown

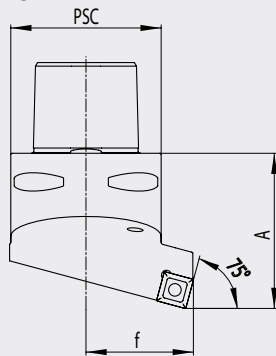

Bestell-Nr. / Order number	PSC	f	D1 min.	A	Wendeplatte/ Insert	Ersatzteile/ Spareparts
PS4.KSB.(R/L)BA.050	40	27	-	50	SC .. 12 04 ..	S09
PS5.KSB.(R/L)BA.060	50	35	-	60	SC .. 12 04 ..	S09
PS6.KSB.(R/L)BA.065	63	45	-	65	SC .. 12 04 ..	S09

PSBN R/L 90°/75°



Bestell-Nr. / Order number	PSC	f	D1 min.	A	Wendeplatte/ Insert	Ersatzteile/ Spareparts
PS4.PSD.(R/L)BA.050	40	27	-	50	SN .. 12 04 ..	P07
PS5.PSD.(R/L)BA.060	50	35	-	60	SN .. 12 04 ..	P07
PS6.PSD.(R/L)BA.065	63	45	-	65	SN .. 12 04 ..	P07

SSSC R/L 90°/45°



- Rechte Ausführung dargestellt
- Right hand shown

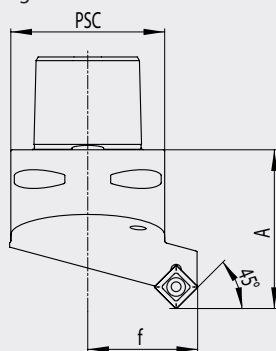

Bestell-Nr. / Order number	PSC	f	D1 min.	A	Wendeplatte/ Insert	Ersatzteile/ Spareparts
PS4.KSA.(R/L)SA.050	40	27	-	50	SC .. 09 T3 ..	S05
PS4.KSB.(R/L)SA.050	40	27	-	50	SC .. 12 04 ..	S09
PS5.KSB.(R/L)SA.060	50	35	-	60	SC .. 12 04 ..	S09
PS6.KSB.(R/L)SA.065	63	45	-	65	SC .. 12 04 ..	S09

PSNN R/L 90°/45°

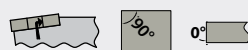

Bestell-Nr. / Order number	PSC	f	D1 min.	A	Wendeplatte/ Insert	Ersatzteile/ Spareparts
PS4.PSD.(R/L)SA.050	40	27	-	50	SN .. 12 04 ..	P07
PS5.PSD.(R/L)SA.060	50	35	-	60	SN .. 12 04 ..	P07
PS6.PSD.(R/L)SA.065	63	45	-	65	SN .. 12 04 ..	P07



SCMC N 50°/80°/50°



Bestell-Nr./ Order number	PSC	A	Wendepplatten/ Inserts	Ersatzteile/ Spareparts
PS6.KCC.NMA.100	63	100	CC .. 12 04 ..	S01
PS6.KCC.NMA.130	63	130	CC .. 12 04 ..	S01

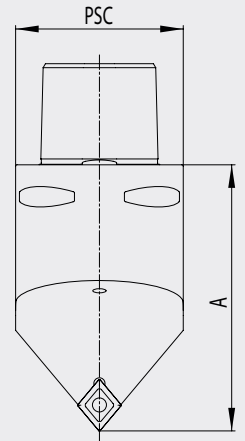

PCMN N 50°/80°/50°



Bestell-Nr./ Order number	PSC	A	Wendepplatten/ Inserts	Ersatzteile/ Spareparts
PS5.PCD.NMA.060	50	60	CN .. 12 04 ..	P01
PS6.PCD.NMA.100-HP	63	100	CN .. 12 04 ..	P01 <small>HP ready</small>
PS6.PCD.NMA.130-HP	63	130	CN .. 12 04 ..	P01 <small>HP ready</small>
PS6.PCE.NMA.100-HP	63	100	CN .. 16 06 ..	P03 <small>HP ready</small>
PS6.PCE.NMA.130-HP	63	130	CN .. 16 06 ..	P03 <small>HP ready</small>

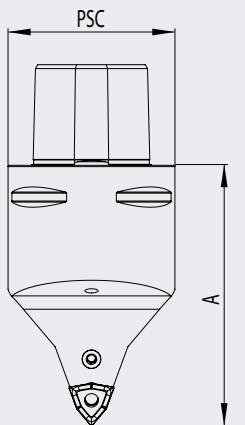

PWMC N 50°/80°/50°



Bestell-Nr./ Order number	PSC	A	Wendepplatten/ Inserts	Ersatzteile/ Spareparts
PS6.PWE.NMA.100	63	100	WN .. 08 04 ..	P04
PS6.PWE.NMA.130	63	130	WN .. 08 04 ..	P04

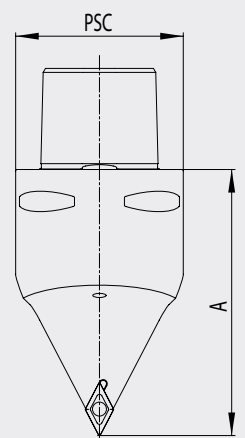

SDNC N 62.5°/55°/62.5°



Bestell-Nr./ Order number	PSC	A	Wendepplatten/ Inserts	Ersatzteile/ Spareparts
PS6.KDB.NNA.100-HP	63	100	DC .. 11 T3 ..	S05 <small>HP ready</small>
PS6.KDB.NNA.130-HP	63	130	DC .. 11 T3 ..	S05 <small>HP ready</small>

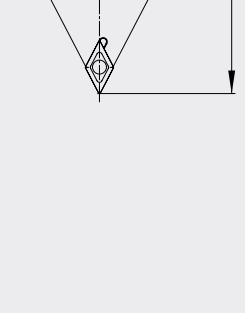

PDNN N 62.5°/55°/62.5°



Bestell-Nr./ Order number	PSC	A	Wendepplatten/ Inserts	Ersatzteile/ Spareparts
PS6.PDF.NNA.100-HP	63	100	DN .. 15 06 ..*	P06 <small>HP ready</small>
PS6.PDF.NNA.130-HP	63	130	DN .. 15 06 ..*	P06 <small>HP ready</small>

* DN .. 15 04 .. möglich mit Unterlegplatte WDF.ER2.101.004

* DN .. 15 04 .. possible with tip pad WDF.ER2.101.004

SVVB N 72.5°/35°/72.5°

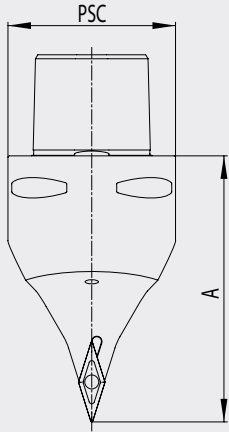

Bestell-Nr. / Order number	PSC	A	Wendeplatten/ Inserts	Ersatzteile/ Spareparts
PS4.KVF.NVA.080	40	80	VB .. 16 04 ..	S07
PS5.KVF.NVA.060	50	60	VB .. 16 04 ..	S07
PS6.KVF.NVA.100	63	100	VB .. 16 04 ..	S07
PS6.KVF.NVA.130	63	130	VB .. 16 04 ..	S07



DVVN N 72.5°/35°/72.5°



Bestell-Nr. / Order number	PSC	A	Wendeplatten/ Inserts	Ersatzteile/ Spareparts
PS6.KVD.NVA.100	63	100	VN .. 16 04 ..	D08
PS6.KVD.NVA.130	63	130	VN .. 16 04 ..	D08



PDMN L 48° (93°)/55°

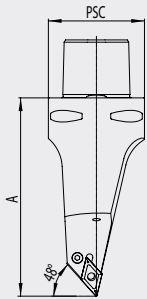

Bestell-Nr. / Order number	PSC	A	Wendeplatten/ Inserts	Ersatzteile/ Spareparts
PS6.PDF.NXA.130-HP	63	130	DN .. 15 06 ..*	P06

* DN .. 15 04 .. möglich mit Unterlegplatte WDF.ER2.101.004

* DN .. 15 04 .. possible with tip pad WDF.ER2.101.004



SVMB L 50° (95°)/35°

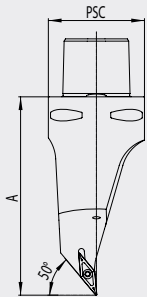

Bestell-Nr. / Order number	PSC	A	Wendeplatten/ Inserts	Ersatzteile/ Spareparts
PS6.KVF.NMA.130	63	130	VB .. 16 04 ..	S07

SVMC L 50° (95°)/35°



Bestell-Nr. / Order number	PSC	A	Wendeplatten/ Inserts	Ersatzteile/ Spareparts
PS6.KVB.NMA.130	63	130	VC .. 16 04 ..	S07

DVMN L 50° (95°)/35°



Bestell-Nr. / Order number	PSC	A	Wendeplatten/ Inserts	Ersatzteile/ Spareparts
PS6.KVD.NMA.130	63	130	VN .. 16 04 ..	D08



T DCM 50° (95°) / DDM 48° (93°)

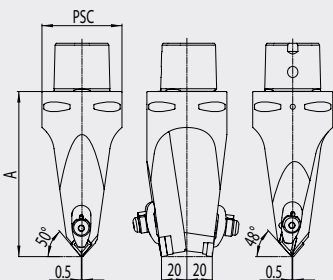

Bestell-Nr. / Order number	PSC	A	Wendeplatten/ Inserts	Ersatzteile/ Spareparts
PS6.KCD.NXD.130	63	130	DN .. 15 06 ..*	D06
			CN .. 12 04 ..	D01

* DN .. 15 04 .. möglich mit Unterlegplatte WDF.ER2.101.004

* DN .. 15 04 .. possible with tip pad WDF.ER2.101.004



Bohrstangen mit Wechselschneidköpfen

- für effiziente Drehbearbeitung
- optimale Kühlung durch ausgerichtete High Pressure Kühldüsen

HP
Inside

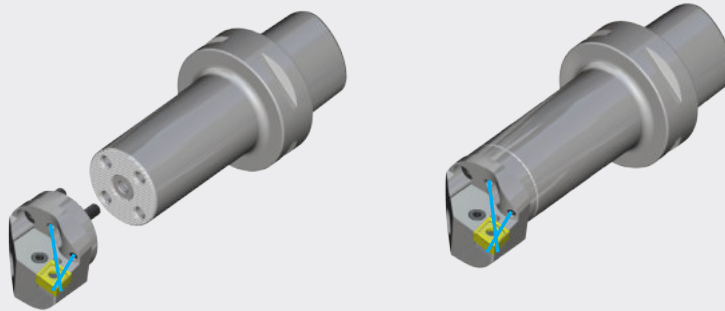

Boring bars with exchangeable cutting heads

- to turn efficiently
- optimal cooling by orientated High Pressure coolant nozzles

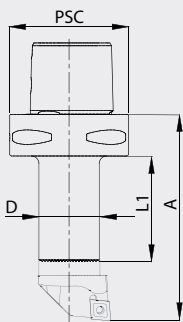

Bohrstangenschäfte

Boring bar shanks

Bestell-Nr. / Order number	PSC	D	A	L1
PS4.WK3.025.090	40	25	90	35
PS4.WK2.032.065	40	32	65	15
PS4.WK2.032.110	40	32	110	55
PS4.WK1.040.120	40	40	120	-
PS5.WK3.025.090	50	25	90	35
PS5.WK2.032.110	50	32	110	55
PS5.WK1.040.140	50	40	140	80
PS6.WK3.025.100	63	25	100	43
PS6.WK2.032.125	63	32	125	68
PS6.WK2.032.160	63	32	160	103
PS6.WK1.040.140	63	40	140	78
PS6.WK1.040.180	63	40	180	118

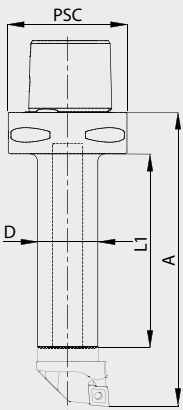

Schwingungsgedämpfte Bohrstangenschäfte

Anti vibration boring bar shanks

Bestell-Nr. / Order number	PSC	D	A	L1
PS6.WK3.025.150	63	25	150	93
PS6.WK2.032.185	63	32	185	128
PS6.WK1.040.225	63	40	225	163

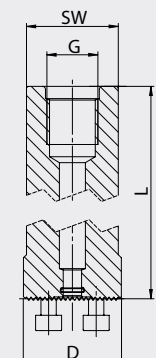

Bohrstangenschäfte mit Zylinderschaft

Boring bar shanks with cylindrical shank

Bestell-Nr. / Order number	D	L	SW	G
U25.WK3.025.200	25	200	23	G1/4
U32.WK2.032.218	32	218	30	G3/8
U40.WK1.040.283	40	283	37	G1/2

- Anschlussgewinde für Innenkühlung
- 3Spannflächen

- with thread for inner coolant supply
- 3 clamping flats



Wechselschneidköpfe

Exchangeable cutting heads

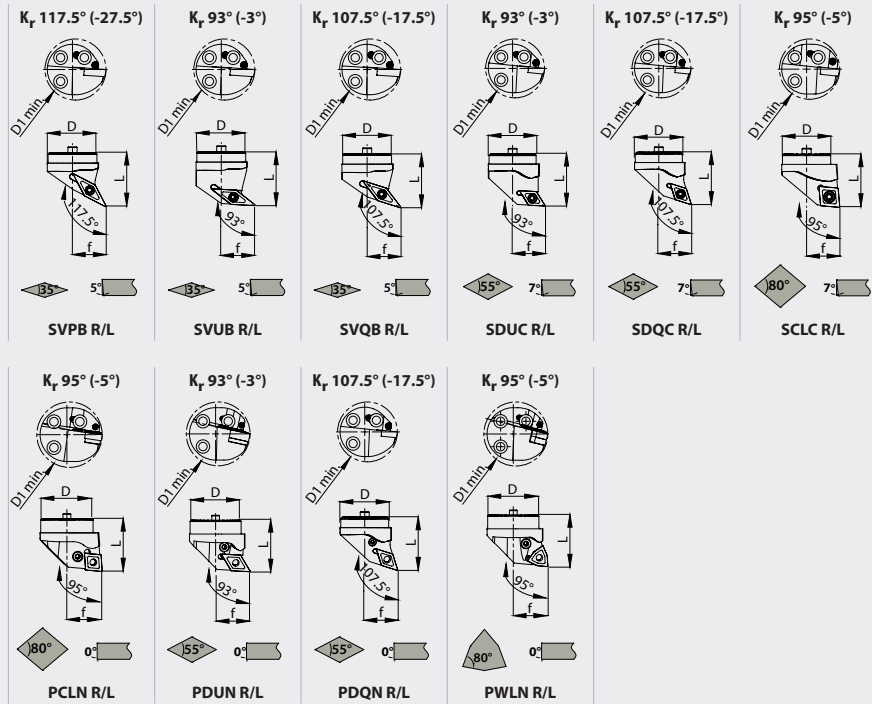

Typ/ Type	Bestell-Nr. / Order number	D	D1 min	f	L	Wendplatte / Insert	Ersatzteile/ Spareparts
SVPB R/L	WK3.BVE.(R/L)PA.035	25	32	17	35	VB .. 11 03 ..	S05
SVPB R/L	WK2.BVF.(R/L)PB.035	32	40	22	35	VB .. 16 04 ..	S07
SVPB R/L	WK1.BVF.(R/L)PC.040	40	50	27	40	VB .. 16 04 ..	S07
SVUB R/L	WK3.BVE.(R/L)UA.035	25	32	17	35	VB .. 11 03 ..	S05
SVUB R/L	WK2.BVF.(R/L)UB.035	32	40	22	35	VB .. 16 04 ..	S07
SVUB R/L	WK1.BVF.(R/L)UC.040	40	50	27	40	VB .. 16 04 ..	S07
SVQB R/L	WK3.BVE.(R/L)QA.035	25	32	17	35	VB .. 11 03 ..	S05
SVQB R/L	WK2.BVF.(R/L)QB.035	32	40	22	35	VB .. 16 04 ..	S07
SVQB R/L	WK1.BVF.(R/L)QC.040	40	50	27	40	VB .. 16 04 ..	S07
SDUC R/L	WK3.BDB.(R/L)UA.035	25	32	17	35	DC .. 11 T3 ..	S05
SDUC R/L	WK2.BDB.(R/L)UB.035	32	40	22	35	DC .. 11 T3 ..	S05
SDUC R/L	WK1.BDB.(R/L)UC.040	40	50	27	40	DC .. 11 T3 ..	S05
SDQC R/L	WK3.BDB.(R/L)QA.035	25	32	17	35	DC .. 11 T3 ..	S05
SDQC R/L	WK2.BDB.(R/L)QB.035	32	40	22	35	DC .. 11 T3 ..	S05
SDQC R/L	WK1.BDB.(R/L)QC.040	40	50	27	40	DC .. 11 T3 ..	S05
SCLC R/L	WK3.BCC.(R/L)LA.035	25	32	17	35	CC .. 12 04 ..	S01
SCLC R/L	WK2.BCC.(R/L)LB.035	32	40	22	35	CC .. 12 04 ..	S01
SCLC R/L	WK1.BCC.(R/L)LC.040	40	50	27	40	CC .. 12 04 ..	S01
PCLN R/L	WK3.PCD.(R/L)LA.035	25	32	17	35	CN .. 12 04 ..	P01
PCLN R/L	WK2.PCD.(R/L)LB.035	32	40	22	35	CN .. 12 04 ..	P01
PCLN R/L	WK1.PCD.(R/L)LC.040	40	50	27	40	CN .. 12 04 ..	P01
PDUN R/L	WK3.PDE.(R/L)UA.035	25	32	17	35	DN .. 11 04 ..	P08
PDUN R/L	WK2.PDE.(R/L)UB.035	32	40	22	35	DN .. 11 04 ..	P08
PDUN R/L	WK1.PDE.(R/L)UC.040	40	50	27	40	DN .. 11 04 ..	P08
PDUN R/L	WK2.PDF.(R/L)UB.035	32	40	22	35	DN .. 15 06 ..	P05
PDUN R/L	WK1.PDF.(R/L)UC.040	40	50	27	40	DN .. 15 06 ..	P05
PDQN R/L	WK3.PDE.(R/L)QA.035	25	32	17	35	DN .. 11 04 ..	P08
PDQN R/L	WK2.PDE.(R/L)QB.035	32	40	22	35	DN .. 11 04 ..	P08
PDQN R/L	WK1.PDE.(R/L)QC.040	40	50	27	40	DN .. 11 04 ..	P08
PWLN R/L	WK2.PWE.(R/L)LB.035	32	40	22	35	WN .. 08 04 ..	P04
PWLN R/L	WK1.PWE.(R/L)LC.040	40	50	27	40	WN .. 08 04 ..	P04

SCLC R/L 95°/80°

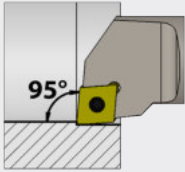

Bestell-Nr./ Order number	PSC	f	D	D1 min.	A	L	Wendeplatte / Insert	Ersatzteile/ Spareparts
PS4.BCC.(R/L)LA.090	40	17	25	32	90	69	CC .. 12 04 ..	S01
PS4.BCC.(R/L)LB.110	40	22	32	40	110	89	CC .. 12 04 ..	S01
PS5.BCC.(R/L)LA.090	50	17	25	32	90	67	CC .. 12 04 ..	S01
PS5.BCC.(R/L)LB.110	50	22	32	40	110	88	CC .. 12 04 ..	S01
PS6.BCC.(R/L)LB.125	63	22	32	40	125	103	CC .. 12 04 ..	S01
PS6.BCC.(R/L)LB.160	63	22	32	40	160	138	CC .. 12 04 ..	S01
PS6.BCC.(R/L)LC.140	63	27	40	50	140	118	CC .. 12 04 ..	S01
PS6.BCC.(R/L)LC.180	63	27	40	50	180	158	CC .. 12 04 ..	S01

- Rechte Ausführung dargestellt
- Right hand shown

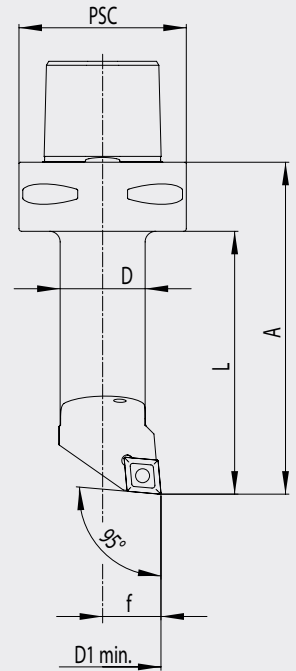

PCLN R/L 95°/80°

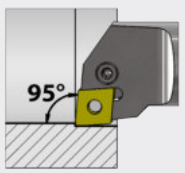

Bestell-Nr./ Order number	PSC	f	D	D1 min.	A	L	Wendeplatte / Insert	Ersatzteile/ Spareparts
PS4.PCD.(R/L)LB.110	40	22	32	40	110	89	CN .. 12 04 ..	P01
PS5.PCD.(R/L)LB.110	50	22	32	40	110	88	CN .. 12 04 ..	P01
PS6.PCD.(R/L)LC.140	63	27	40	50	140	118	CN .. 12 04 ..	P01
PS6.PCD.(R/L)LC.180	63	27	40	50	180	158	CN .. 12 04 ..	P01

- Rechte Ausführung dargestellt
- Right hand shown

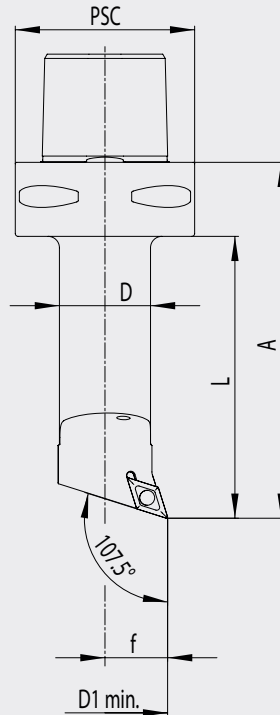

SDQC R/L 107.5°/55°

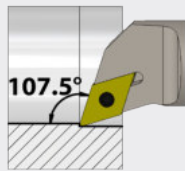

Bestell-Nr./ Order number	PSC	f	D	D1 min.	A	L	Wendeplatte / Insert	Ersatzteile/ Spareparts
PS4.BDB.(R/L)QA.090	40	17	25	32	90	69	DC .. 11 T3 ..	S05
PS4.BDB.(R/L)QB.110	40	22	32	40	110	89	DC .. 11 T3 ..	S05
PS5.BDB.(R/L)QA.090	50	17	25	32	90	67	DC .. 11 T3 ..	S05
PS5.BDB.(R/L)QB.110	50	22	32	40	110	88	DC .. 11 T3 ..	S05
PS6.BDB.(R/L)QB.125	63	22	32	40	125	103	DC .. 11 T3 ..	S05
PS6.BDB.(R/L)QB.160	63	22	32	40	160	138	DC .. 11 T3 ..	S05
PS6.BDB.(R/L)QC.140	63	27	40	50	140	118	DC .. 11 T3 ..	S05
PS6.BDB.(R/L)QC.180	63	27	40	50	180	158	DC .. 11 T3 ..	S05

- Rechte Ausführung dargestellt
- Right hand shown

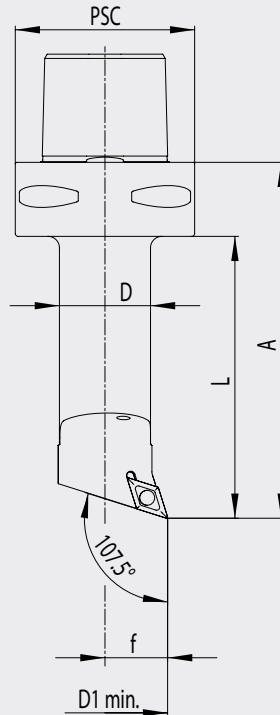

PDQN R/L 107.5°/55°

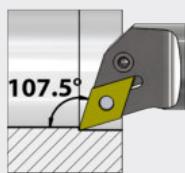

Bestell-Nr./ Order number	PSC	f	D	D1 min.	A	L	Wendeplatte / Insert	Ersatzteile/ Spareparts
PS4.PDF.(R/L)QB.110	40	22	32	40	110	89	DN .. 15 06 .. *	P05
PS5.PDF.(R/L)QB.110	50	22	32	40	110	88	DN .. 15 06 .. *	P05
PS6.PDF.(R/L)QC.140	63	27	40	50	140	118	DN .. 15 06 .. *	P05
PS6.PDF.(R/L)QC.180	63	27	40	50	180	158	DN .. 15 06 .. *	P05

* DN .. 15 04 .. möglich mit Unterlegplatte WDF.ER2.101.004

* DN .. 15 04 .. possible with tip pad WDF.ER2.101.004

Bohrstangenhalter

Boring bar holder

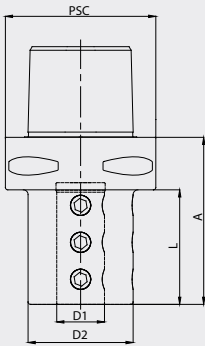

Bestell-Nr. / Order number	PSC	D1	D2	A	L
PS4.B06.K01.065	40	6	34	65	43
PS4.B08.K01.065	40	8	34	65	43
PS4.B10.K01.065	40	10	34	65	43
PS4.B12.K01.065	40	12	36	65	43
PS4.B16.K01.065	40	16	40	65	43
PS4.B20.K01.065	40	20	44	65	-
PS4.B25.K01.065	40	25	44	65	-
PS5.B06.K01.070	50	6	34	70	48
PS5.B08.K01.070	50	8	34	70	48
PS5.B10.K01.070	50	10	34	70	48
PS5.B12.K01.070	50	12	36	70	48
PS5.B16.K01.070	50	16	40	70	48
PS5.B20.K01.070	50	20	44	70	48
PS5.B25.K01.070	50	25	50	70	-
PS5.B32.K01.070	50	32	56	70	-
PS6.B06.K01.080	63	6	34	80	58
PS6.B08.K01.080	63	8	34	80	58
PS6.B10.K01.080	63	10	34	80	58
PS6.B12.K01.080	63	12	36	80	58
PS6.B14.K01.080	63	14	38	80	58
PS6.B16.K01.080	63	16	40	80	58
PS6.B18.K01.080	63	18	42	80	58
PS6.B20.K01.080	63	20	44	80	58
PS6.B25.K01.100	63	25	50	100	78
PS6.B32.K01.100	63	32	56	100	78
PS6.B40.K01.105	63	40	63	105	83
PS8.B10.K01.098	80	10	34	98	68
PS8.B12.K01.098	80	12	36	98	68
PS8.B16.K01.098	80	16	40	98	68
PS8.B20.K01.098	80	20	44	98	68
PS8.B25.K01.098	80	25	50	98	68
PS8.B32.K01.112	80	32	56	112	82
PS8.B40.K01.112	80	40	63	112	82
PS8.B50.K01.112	80	50	82	112	-

**Werkzeughalter für
Wendepplattenbohrer**

**Toolholder for
indexable insert drills**

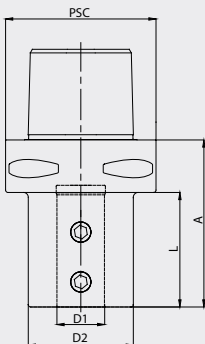

- zum Spannen von Zylinderschäften nach DIN 6595-1 / ISO 9766
- to clamp cylindrical shanks DIN 6595-1 / ISO 9766

Bestell-Nr. / Order number	PSC	D1	D2	A	L
PS4.K16.K01.056	40	16	36	56	36
PS4.K20.K01.060	40	20	40	60	-
PS4.K25.K01.077	40	25	45	77	-
PS5.K16.K01.065	50	16	36	65	45
PS5.K20.K01.060	50	20	40	60	40
PS5.K25.K01.071	50	25	45	71	51
PS5.K32.K01.075	50	32	52	75	-
PS6.K16.K01.070	63	16	36	70	48
PS6.K20.K01.070	63	20	40	70	48
PS6.K25.K01.072	63	25	45	72	50
PS6.K32.K01.075	63	32	52	75	53
PS6.K40.K01.085	63	40	63	85	-

Abstechhalter radial

Cut-off block radial

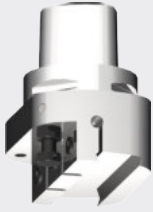

Bestell-Nr./ Order number	PSC	A	H	L	ØD	rechts/links right/left
PS4.AM2.K11.055	40	55	26	50.5	80	R/L
PS5.AM3.K11.058	50	58	26	53	80	R/L
PS6.AM3.K11.060	63	60	32	54.5	100	R/L

- zur Aufnahme von Stechschwertern
- mit Innenkühlung

- to hold cut-off blades
- with inner coolant supply

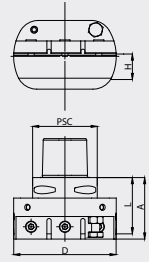
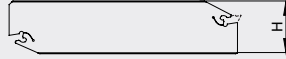

Abstechhalter axial

Cut-off block axial



Bestell-Nr./ Order number	PSC	f	A	H	L	ØD	rechts/links right/left
PS5.AM3.K11.095	50	22	95	26	75	80	R
PS5.AM3.K12.095	50	22	95	26	75	80	L
PS6.AM3.K11.145	63	22	145	32	110	80	R
PS6.AM3.K12.145	63	22	145	32	110	80	L

- zur Aufnahme von Stechschwertern
- mit Innenkühlung

- to hold cut-off blades
- with inner coolant supply

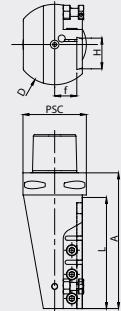

- Rechte Ausführung dargestellt
- Right hand shown

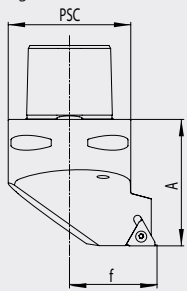

(axial)

Aussengewinde radial

External thread radial

Bestell-Nr. / Order number	PSC	f	D1 min.	A	R/L	Wendeplatte/ Insert	Ersatzteile/ Spareparts
PS4.KGB.RGR.050	40	27	-	50	R	16 ER	G01
PS4.KGB.LGR.050	40	27	-	50	L	16 EL	G02
PS5.KGB.RGR.060	50	35	-	60	R	16 ER	G01
PS5.KGB.LGR.060	50	35	-	60	L	16 EL	G02
PS6.KGB.RGR.065	63	45	-	65	R	16 ER	G01
PS6.KGB.LGR.065	63	45	-	65	L	16 EL	G02



Aussengewinde axial

External thread axial

Bestell-Nr. / Order number	PSC	f	D1 min.	A	R/L	Wendeplatte/ Insert	Ersatzteile/ Spareparts
PS4.KGB.RGA.050	40	27	-	50	R	16 EL	G04
PS4.KGB.LGA.050	40	27	-	50	L	16 ER	G03
PS5.KGB.RGA.060	50	35	-	60	R	16 EL	G04
PS5.KGB.LGA.060	50	35	-	60	L	16 ER	G03
PS6.KGB.RGA.065	63	45	-	65	R	16 EL	G04
PS6.KGB.LGA.065	63	45	-	65	L	16 ER	G03



- Rechte Ausführung dargestellt
- Right hand shown

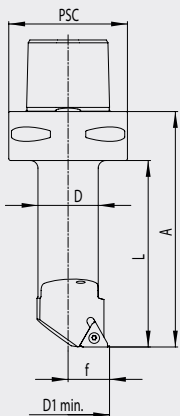

Innengewinde

Internal thread

Bestell-Nr. / Order number	PSC	f	D	D1 min.	A	L	Wendepl./ Insert	Ersatz./ Sparep.
PS6.BGB.RGA.125	63	22	32	40	125	103	16 IL	G04
PS6.BGB.LGA.125	63	22	32	40	125	103	16 IR	G03
PS6.BGB.RGA.140	63	27	40	50	140	138	16 IL	G04
PS6.BGB.LGA.140	63	27	40	50	140	138	16 IR	G03



Wechselschneidköpfe für Innengewinde

Exchangeable cutting heads for Internal thread

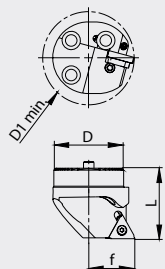

Bestell-Nr. / Order number	D	D1 min.	f	L	Wendeplatte / Insert	Ersatzteile/ Spareparts
WK3.BGB.RGA.035	25	32	17	35	16 IL	G04
WK3.BGB.LGA.035	25	32	17	35	16 IR	G03
WK2.BGB.RGB.040	32	40	22	40	16 IL	G04
WK2.BGB.LGB.040	32	40	22	40	16 IR	G03
WK1.BGB.RGC.040	40	50	27	40	16 IL	G04
WK1.BGB.LGC.040	40	50	27	40	16 IR	G03



• Bohrstangenschäfte siehe Seite 21

• Boring bar shanks page 21

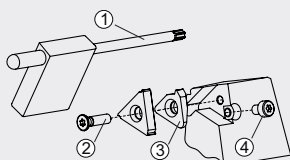

Für Gewindehalter For thread tool	Typ/ Type	Bestell-Nr. / Order number	Bestell-Nr. / Order number	Bestell-Nr. / Order number	Bestell-Nr. / Order number
		Torx-Schlüssel/ Torx driver	Torx-Schraube Torx screw	Zwischenlage/ Tip pad	Schraube/ Screw
xxx.KGB.RGR.xxx	G01	WGB.ER1.001.000	WGB.ER2.001.012	WGB.ER2.102.003	WGB.ER3.001.007
xxx.KGB.LGR.xxx	G02	WGB.ER1.001.000	WGB.ER2.001.012	WGB.ER2.101.003	WGB.ER3.001.007
xxx.xGB.RGA.xxx	G03	WGB.ER1.001.000	WGB.ER2.001.012	WGB.ER2.101.003	WGB.ER3.001.007
xxx.xGB.LGA.xxx	G04	WGB.ER1.001.000	WGB.ER2.001.012	WGB.ER2.102.003	WGB.ER3.001.007



Werkzeughalter axial

Tool holder axial

Bestell-Nr. / Order number	PSC	B	Vierkant Square	A	L	ØD
PS4.V20.(R/L)11.080	40	30	20x20	80	60	80
PS4.V25.(R/L)11.080	40	31	25x25	80	56	80
PS5.V20.(R/L)11.098	50	30	20x20	98	75	80
PS5.V25.(R/L)11.098	50	35	25x25	98	75	95
PS6.V20.(R/L)11.100	63	30	20x20	100	75	80
PS6.V25.(R/L)11.130	63	38	25x25	130	102	102
PS8.V32.(R/L)11.140	80	40	32x32	140	98	110

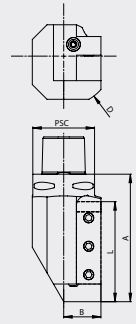

Werkzeughalter axial doppelt

Tool holder axial double

Bestell-Nr. / Order number	PSC	B	Vierkant Square	A	L	ØD
PS4.V20.(R/L)21.080	40	30	20x20	80	60	80
PS5.V20.(R/L)21.098	50	30	20x20	98	75	80
PS6.V20.(R/L)21.100	63	30	20x20	100	75	80
PS6.V25.(R/L)21.130	63	40	25x25	130	102	102

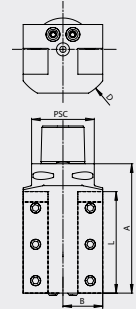

Werkzeughalter axial dreifach

Tool holder axial triple

Bestell-Nr. / Order number	PSC	B	Vierkant Square	A	L	ØD
PS5.V16.R31.098	50	30	16x16	98	75	70
PS5.V20.(R/L)31.123	50	36	20x20	123	97	90
PS6.V20.(R/L)31.125	63	36	20x20	125	97	90
PS6.V25.(R/L)31.130	63	40	25x25	130	102	102

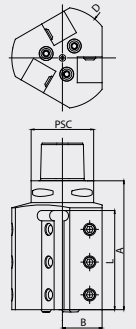

Werkzeughalter radial

Tool holder radial

Bestell-Nr. / Order number	PSC	B	Vierkant Square	A	ØD
PS4.V20.N11.055	40	30	20x20	55	80
PS5.V20.N11.058	50	30	20x20	58	80
PS5.V25.N11.058	50	30	25x25	58	80
PS6.V20.N11.060	63	30	20x20	60	80
PS6.V25.N11.071	63	40	25x25	71	102
PS8.V32.N11.085	80	55	32x32	85	132

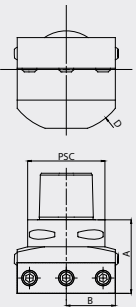

Werkzeughalter diagonal 45°

Tool holder diagonal 45°

Bestell-Nr. / Order number	PSC	f	Vierkant Square	A	ØD
PS5.V20.R12.098	50	15	20x20	98	80 R
PS5.V20.L12.098	50	15	20x20	98	80 L
PS6.V20.R12.100	63	15	20x20	100	80 R
PS6.V20.L12.100	63	15	20x20	100	80 L
PS6.V25.R12.110	63	15	25x25	110	102 R
PS6.V25.L12.110	63	15	25x25	110	102 L

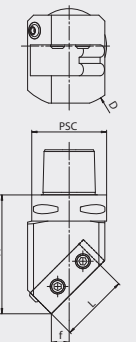

- Linke Ausführung dargestellt
- Left hand shown

Verlängerung

Extension

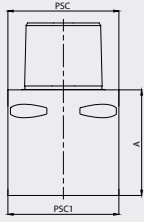

Bestell-Nr. / Order number	PSC	PSC 1	A
PS4.PS4.K01.060	40	40	60
PS4.PS4.K01.080	40	40	80
PS5.PS5.K01.080	50	50	80
PS5.PS5.K01.100	50	50	100
PS6.PS6.K01.060	63	63	60
PS6.PS6.K01.100	63	63	100



Reduktion

Reduction

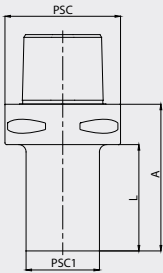

Bestell-Nr. / Order number	PSC	PSC 1	L	A
PS5.PS4.K01.065	50	40	40	65
PS6.PS4.K01.080	63	40	58	80
PS6.PS5.K01.080	63	50	51	80



Rohling

Blank

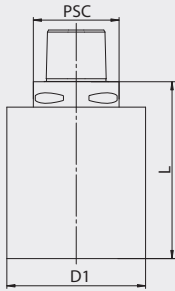

Bestell-Nr. / Order number	PSC	D1	L
PS4.Ro5.001.050	40	54	50
PS4.Ro8.001.080	40	80	80
PS5.Ro7.001.060	50	70	60
PS5.Ro8.001.098	50	80	98
PS5.Ro9.001.123	50	90	123
PS6.Ro6.001.100	63	63	100
PS6.Ro0.001.130	63	102	130

Trennstellenverschluss

Blanking plug

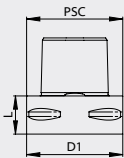

Bestell-Nr. / Order number	PSC	D1	L
PS4.000.001.020	40	40	20
PS5.000.001.020	50	50	20
PS6.000.001.025	63	63	25



**Kühlmitelrohr
Montageschlüssel**

**Coolant tube
assembling key**

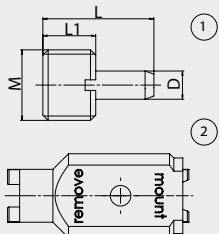

Bestell-Nr. / Order number	PSC	M	L	L1	D
PS4.ER1.014.026 ①	40	14x1.5	26	12	6
PS4.ER4.002.090 ②	40				
PS5.ER1.016.029 ①	50	16x1.5	29	14	7
PS5.ER4.002.090 ②	50				
PS6.ER4.001.087 ①	63	20x2	31.5	15	8
PS6.ER4.002.090 ②	63				



Ersatzteile / Zubehör

Spare parts / Accessories

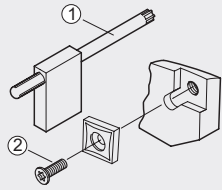

Für Klemmhalter/ Bohrstange For turning tool/ boring bar	Typ/ Type	Bestell-Nr. / Order number ^①	Bestell-Nr. / Order number ^②
		Torx-Schlüssel/ Torx driver	Torx-Schraube Torx screw
xxx.xCC.xxx.xxx	S01	WCC.ER1.001.000	WCC.ER2.001.010
xxx.xCD.xxx.xxx	S02	WCC.ER1.001.000	WCC.ER2.001.010
xxx.xCE.xxx.xxx	S03	WCE.ER1.001.000	WCE.ER2.001.012
xxx.xWE.xxx.xxx	S04	WCC.ER1.001.000	WCC.ER2.001.010
xxx.xDB.xxx.xxx	S05	WCB.ER1.001.000	WCB.ER2.001.009
xxx.xDF.xxx.xxx	S06	WCC.ER1.001.000	WCC.ER2.001.010
xxx.xVF/VB.xxx.xxx	S07	WCB.ER1.001.000	WCB.ER2.001.009
xxx.xVD.xxx.xxx	S08	WCB.ER1.001.000	WCB.ER2.001.009
xxx.xSB.xxx.xxx	S09	WCC.ER1.001.000	WCC.ER2.001.010
xxx.xVE/VA.xxx.xxx	S10	WCA.ER1.001.000	WCA.ER2.001.006

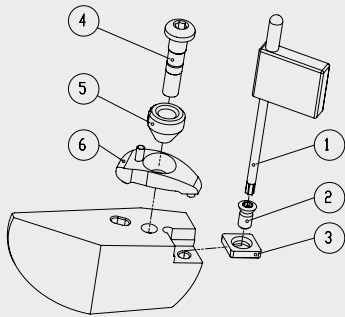

Für Klemmhalter/ Bohrstange For turning tool/ boring bar	Typ/ Type	Bestell-Nr. / Order number ^③	Bestell-Nr. / Order number ^④	Bestell-Nr. / Order number ^⑤	Bestell-Nr. / Order number ^⑥
		Zwischenlage/ Tip pad	Spannschraube/ Clamping screw	Düsenring/ Nozzle ring	Spannpratze/ Clamping short
xxx.xCD.xxx.xxx	D01	WCD.ER2.101.003	WCC.ER4.103.032	WCC.ER5.102.012	WCC.ER3.102.024
xxx.KCE.R/Lxx.xxx	D02	WCE.ER2.101.004	WCC.ER4.103.032	WCC.ER5.102.012	WCC.ER3.102.024
xxx.KCE.Nxx.xxx	D03	WCE.ER2.101.004	WCC.ER4.103.032	WCC.ER5.102.012	WCC.ER3.102.029
xxx.KWE.R/Lxx.xxx	D04	WWE.ER2.101.004	WCC.ER4.103.032	WCC.ER5.102.012	WCC.ER3.102.024
xxx.xDF.R/Lxx.xxx	D05	WDF.ER2.101.003	WCC.ER4.103.032	WCC.ER5.102.012	WCC.ER3.102.024
xxx.KDF.Nxx.xxx	D06	WDF.ER2.101.003	WCC.ER4.103.032	WCC.ER5.102.012	WCC.ER3.102.029
xxx.xVD.R/Lxx.xxx	D07	WVD.ER2.101.003	WCC.ER4.103.032	WCC.ER5.102.012	WCC.ER3.102.024
xxx.KVD.Nxx.xxx	D08	WVD.ER2.101.003	WCC.ER4.103.032	WCC.ER5.102.012	WCC.ER3.102.029
xxx.KSD.R/Lxx.xxx	D09	WSD.ER2.101.003	WCC.ER4.103.032	WCC.ER5.102.012	WCC.ER3.102.024

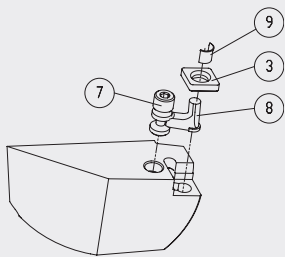

Für Klemmhalter/ Bohrstange For turning tool/ boring bar	Typ/ Type	Bestell-Nr. / Order number ^③	Bestell-Nr. / Order number ^⑦	Bestell-Nr. / Order number ^⑧	Bestell-Nr. / Order number ^⑨
		Zwischenlage/ Tip pad	Spannschraube/ Clamping screw	Kniehebel/ Lever	Rohrstift/ Hollow pin
xxx.PCD.xxx.xxx	P01	WCD.ER2.101.003	WCD.ER4.101.017	WCD.ER3.101.000	WCD.ER1.101.000
xxx.PCE.R/Lxx.xxx	P02	WCE.ER2.101.004	WCE.ER4.101.004	WCE.ER3.101.000	WCE.ER1.101.000
xxx.PCE.Nxx.xxx	P03	WCE.ER2.101.004	WCE.ER4.101.004	WCE.ER3.101.000	WCE.ER1.101.000
xxx.PWE.R/Lxx.xxx	P04	WWE.ER2.101.004	WCD.ER4.101.017	WDF.ER3.101.000	WCD.ER1.101.000
xxx.PDF.R/Lxx.xxx	P05	WDF.ER2.101.003	WCD.ER4.101.017	WDF.ER3.101.000	WCD.ER1.101.000
xxx.PDF.Nxx.xxx	P06	WDF.ER2.101.003	WCD.ER4.101.017	WDF.ER3.101.000	WCD.ER1.101.000
xxx.PSD.R/Lxx.xxx	P07	WSD.ER2.101.003	WCD.ER4.101.017	WCD.ER3.101.000	WCD.ER1.101.000
xxx.PDE.xxx.xxx.xxx	P08	WDE.ER2.101.003	WDE.ER4.101.017	WDE.ER3.101.000	WDE.ER1.101.000
xxx.PCF.xxx.xxx	P09	WCF.ER2.101.000	WCF.ER4.101.027	WCF.ER3.101.000	WCF.ER1.101.000
xxx.PSE.xxx.xxx	P10	WSE.ER2.101.004	WCE.ER4.101.004	WCE.ER3.101.000	WCE.ER1.101.000

Für Werkzeughalter/
Für Bohrstangenhalter
For tool holder/
For boring bar holder

Bestell-Nr. /
Order number

	Klemmschraube/ Clamping screw	Dimension
xxx.V20.xxx.xxx	ERU.GS6.001.018	M10 x 18
xxx.V25.xxx.xxx	ERU.GS7.001.025	M12 x 25
xxx.B06.xxx.xxx	ERU.GS4.001.010	M 6 x 10
xxx.B08...B12.xxx.xxx	ERU.GS5.001.010	M 8 x 10
xxx.B16...B40.xxx.xxx	ERU.GS6.001.012	M10 x 12

Bezeichnung von PSC Klemhalter
für Aussenbearbeitung

Identification of external PSC
turning tool holder

PSC 63 | D | C | L | N | R | 45 | 065 | 12
1 | 2 | 3 | 4 | 5 | 6 | 7 | 8 | 9

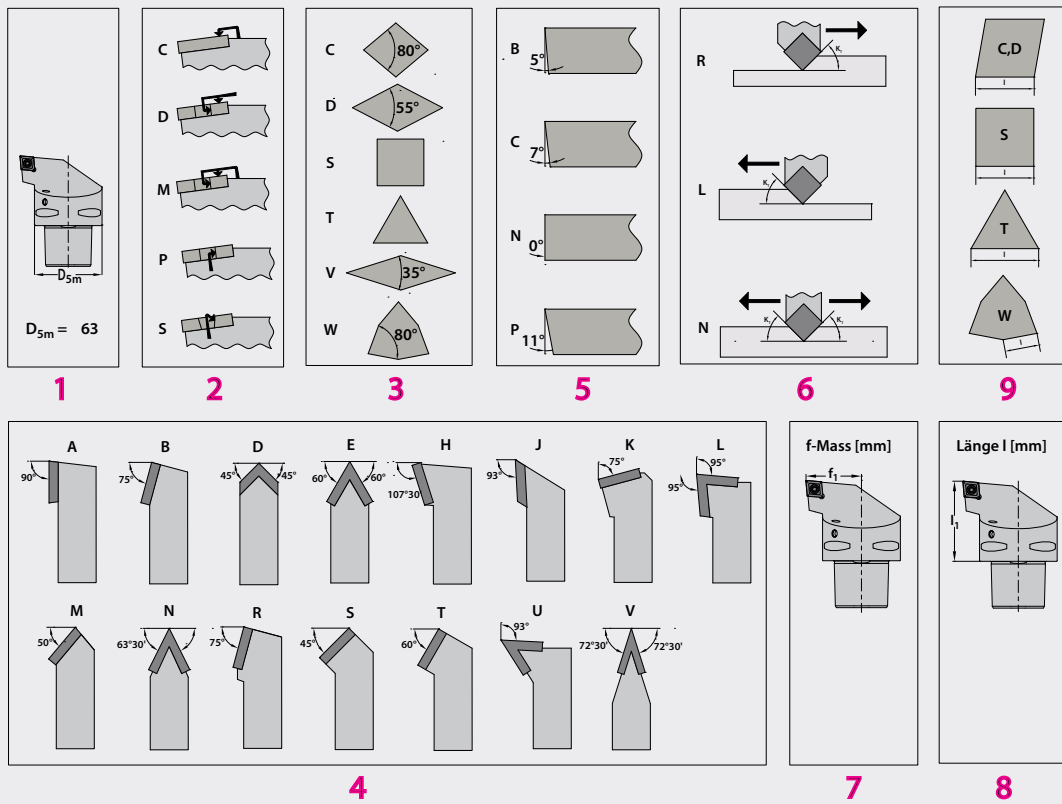

Bezeichnung von PSC Klemhalter
für Innenbearbeitung

Identification of internal PSC
turning tool holder

PSC 63 | S | C | L | C | R | - | 27180 | - | 09
1 | 2 | 3 | 4 | 5 | 6 | 7 | 8

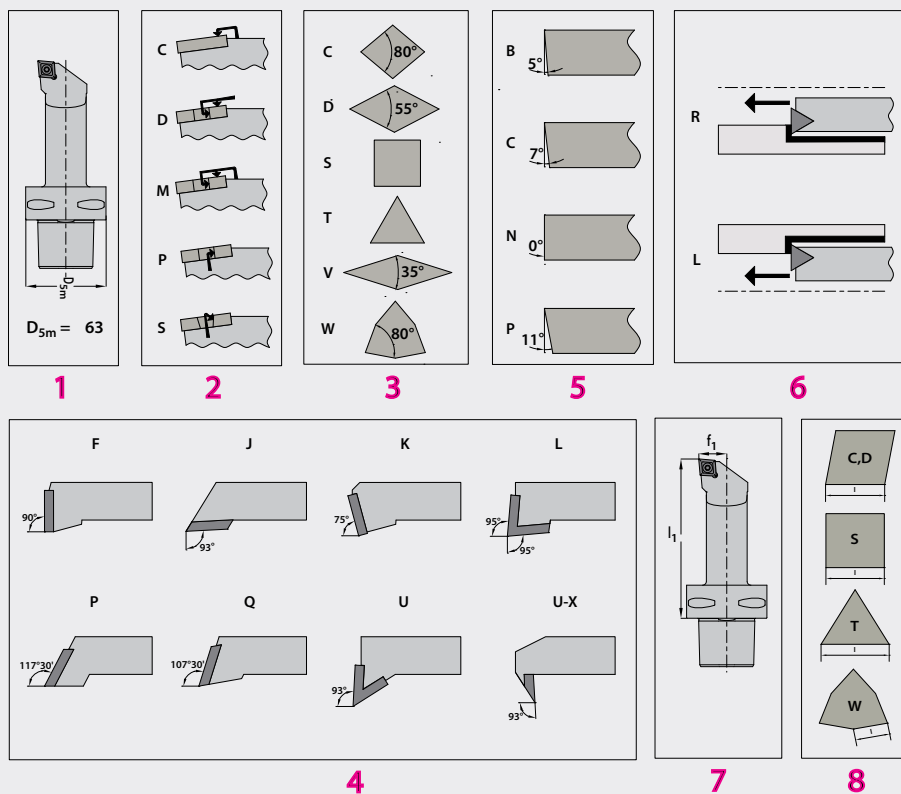

SWISS  TOOLS[®] Swiss Tool Systems AG
Wydenstrasse 28
CH-8575 Bürglen
Phone +41 (0)71 634 85 20
Fax +41 (0)71 634 85 29
www.swisstools.org