

escomatic D2/D5 CNC 2020

ESCONOMY OF SCALE



The escomatic concept

Unlike conventional lathes, escomatic lathes are based on a unique concept. The material, which is coil stock or bar, does not rotate. The cutting tools mounted onto the spinning tool head rotate around the material. This concept equally qualified for the manufacturing of small, medium and large lot size parts, contributes to the extremely high performance and cost savings achieved with escomatic machines.

Technical specifications

- The escomatic technology with 2 turning tools on the rotating tool head
- Choice of escomatic cutting tools or inserts from other suppliers
- High speed manufacturing thanks to the independent front and rear machining units
- Easy programming by using the simplified user interface
- Easy access for the operator guaranteed by the complete opening of the frontal guarding

Very high profitability thanks to:

- Unrivalled productivity of the escomatic principle
- Very short turning times thanks to the proximity of tools
- 24 hours production facilitated by coil feeding
- No lost time due to bar loading
- Man-hour gain in material feeding
- Limited waist of material ends
- Low maintenance costs

Applications:

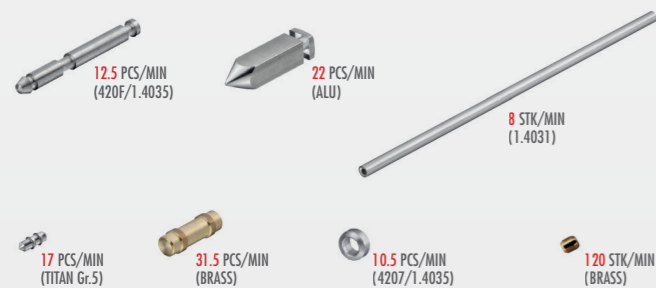

TECHNICAL DATA

Turning

Maximum part diameter	4	mm
Standard workpiece length	80	mm
Number of cutting tools	2	
Max. tool head speed	12'000	min ⁻¹
Material feed rate	8	m/min

Straightening

Straightening unit		
Maximum straightening length	80	mm
Rotation speed of straightening unit	600-3'400	min ⁻¹

D2 CNC

Device counter collet unit

Counter collet unit mobile		
Counter collet unit fix(option)		

D5 CNC

Front machining unit

Max. drilling diameter	3	mm
Max. drilling speed	18'000	t/min
Max. drilling length	20	mm
Max. tapping/threading diameter	M3	
Max. tapping/threading diameter	6'000	t/min
Rigid tapping	yes	

Options/Back machining unit DUAL

1 axial powered spindle		
Max. drilling speed	18'000	t/min
Max. drilling diameter	3	mm
Max. drilling length	20	mm
Max. tapping/threading diameter	M2	
1 radial powered spindle		
Max. speed	18'000	t/min
Max. drilling diameter	2.5	mm

Technical features

Coolant/cutting fluid	oil	
Tank capacity	80	l
Flow rate of the pump	11.5	l/min
Max. system pressure	10	bar
Chips container capacity	18	l
Installed Power	4	kVA
Compressed air consumption	7	m ³ /h
Compressed air pressure	5	bar

Dimensions & weight

Length x Width x Height	1'360 x 750 x 1'560	mm
L x W x H with coil reel	2'400 x 1'000 x 1'560	mm
Net weight	850	kg
Gross weight	1'050	kg

Modifications reserved

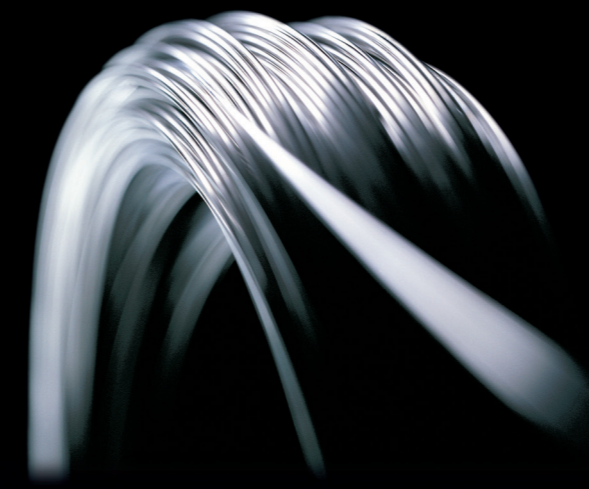
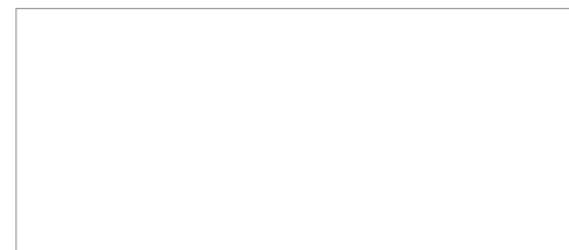

escomatic

D2/D5 CNC 2020

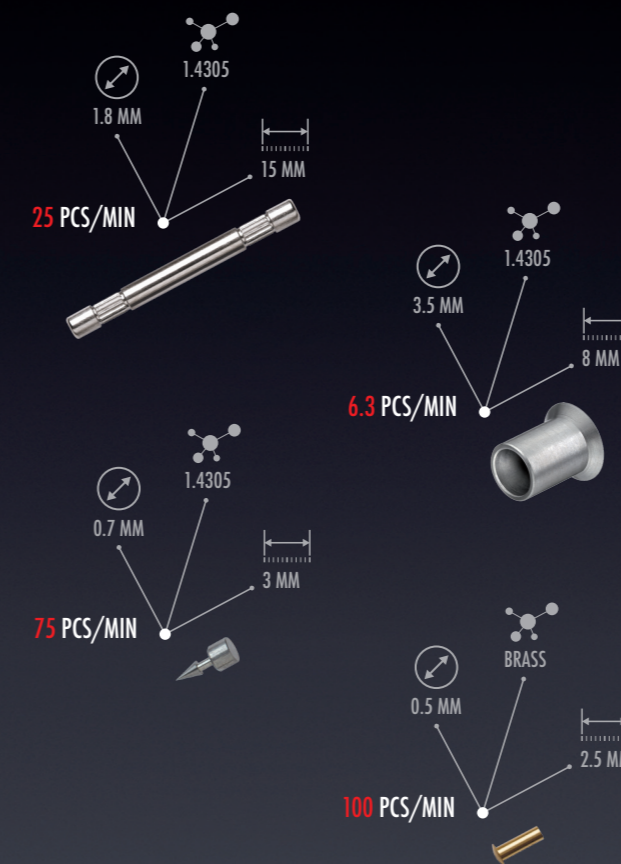

PRODUCTIVITY
OF THE CAMS

AND FLEXIBILITY
OF THE CNC

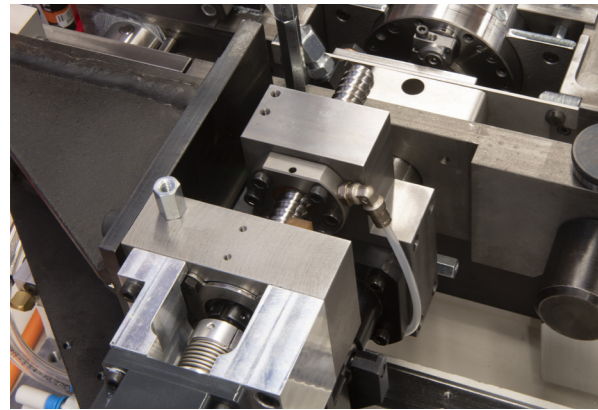

**D2 CNC
MOBILE COUNTER COLLET**

Before cutting off of the finished part from the stock material, the work piece is clamped by the counter collet. After cut-off the part is pushed by the following work piece across the counter collet and ejected into a container.

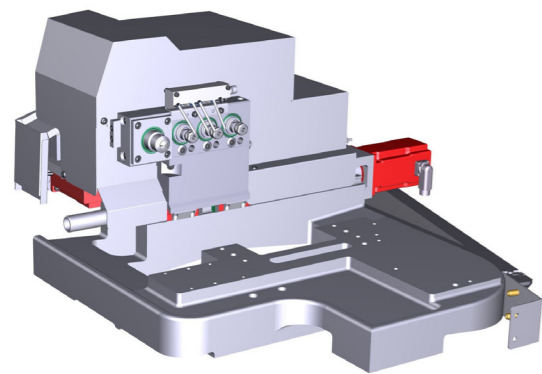

**D5 CNC
DEVICE OF FRONTAL AND BACK MACHINING**

The counter collet of the machine D2 has been replaced by a system for the front machining which consists of a cross table with 2 axes supporting: 2 drilling spindles, 1 threading / tapping spindle and 1 counter collet with programmable positioning. For the back machining a counter spindle with C-axis and a cross spindle are available on a separate CNC table. Optionnally, a vertically mounted spindle could be mounted for milling in place of the standard counter spindle.



TURNING

While the material is held by a guide bush, the turning and chip removal is performed by the unique escomatic principle. This consists of having the cutting tools rotating around the material with a speed up to 12'000 rpm. When cutting off, the counter collet holds the machined part for a perfect flatness and a cut-off tip free end.

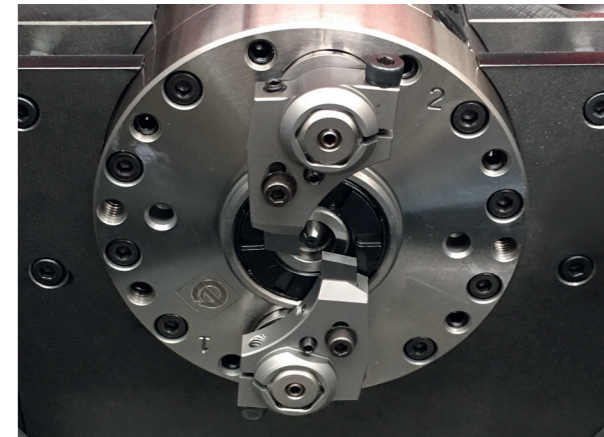

MATERIAL FEED

The material is supplied into the machine from coil. A coil, depending on the type of material, usually has 30 to 50 kg and is unrolled from a reel supported by the machine. The material is pulled across the machine by the material feed system.

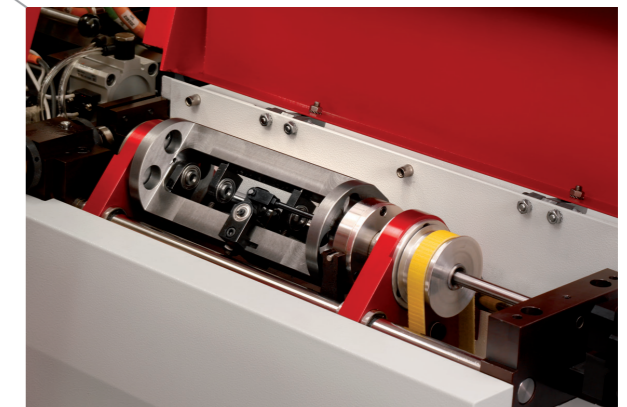

MATERIAL STRAIGHTENING

The material is fed into the machine from a coil which becomes bar stock after the straightening process. It produces a bar with a straightness quality equivalent to standard bar stock.

MATERIAL FEEDING

The material is clamped between a set of grooved rollers and their rotation controls the feeding. The clamping pressure is adjustable and the grooves have the shape of the wire. With this principle and the closeness of the guide bush, very small wire can be machined without bending or whipping (down to 0.30 mm).

